

# Planer til Forelæsninger over Huusbygningskunsten

for

## Officeerskolens Ingenieurafdeling

af

**E. J. SOMMERFELDT,**  
Ingenieurcapitain.

I. Materialer og enkelte Forbindelser.

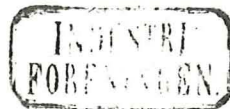

KJØBENHAVN.

**C. A. Reitzels Forlag.**

1878.



fig 1

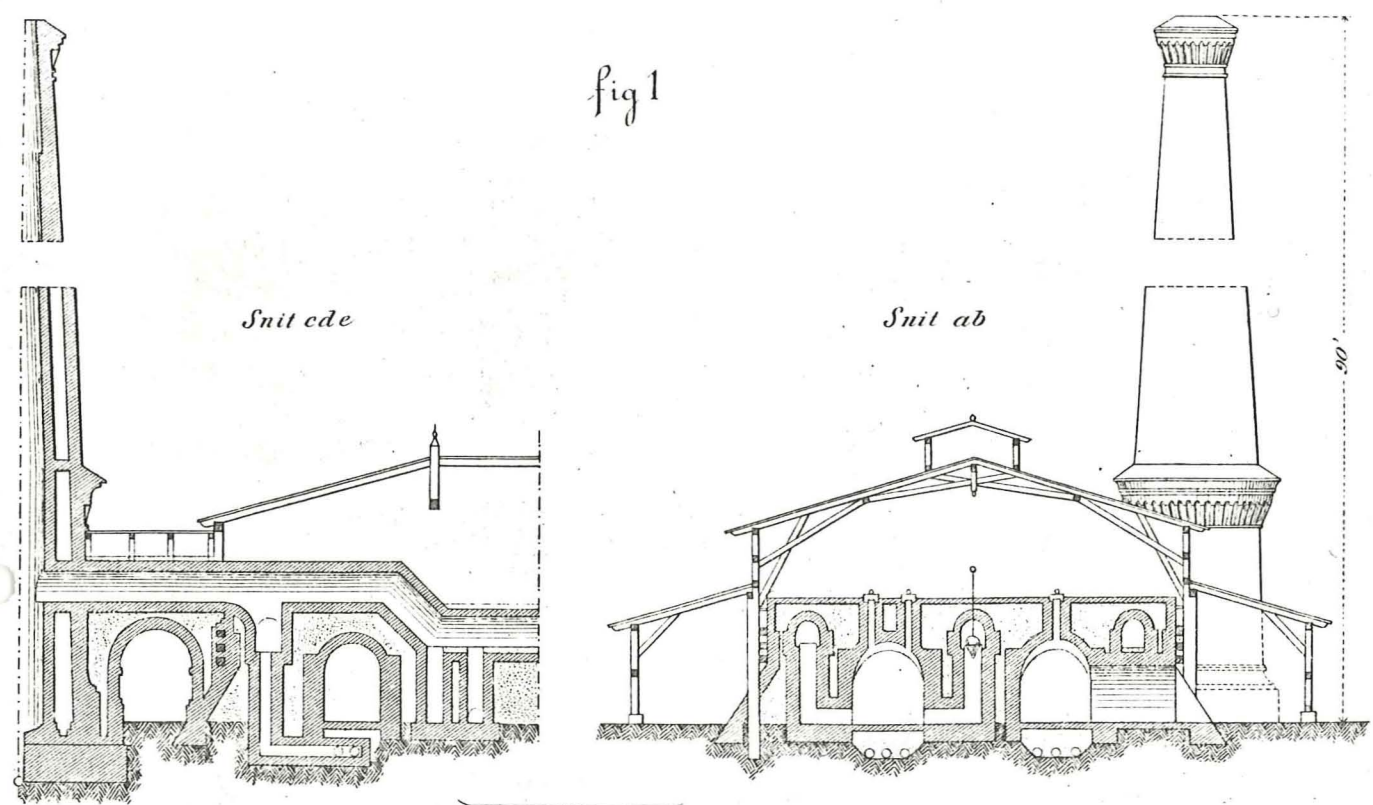

Plan.

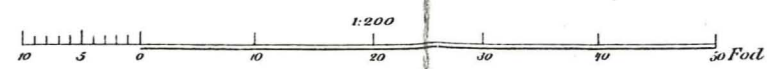
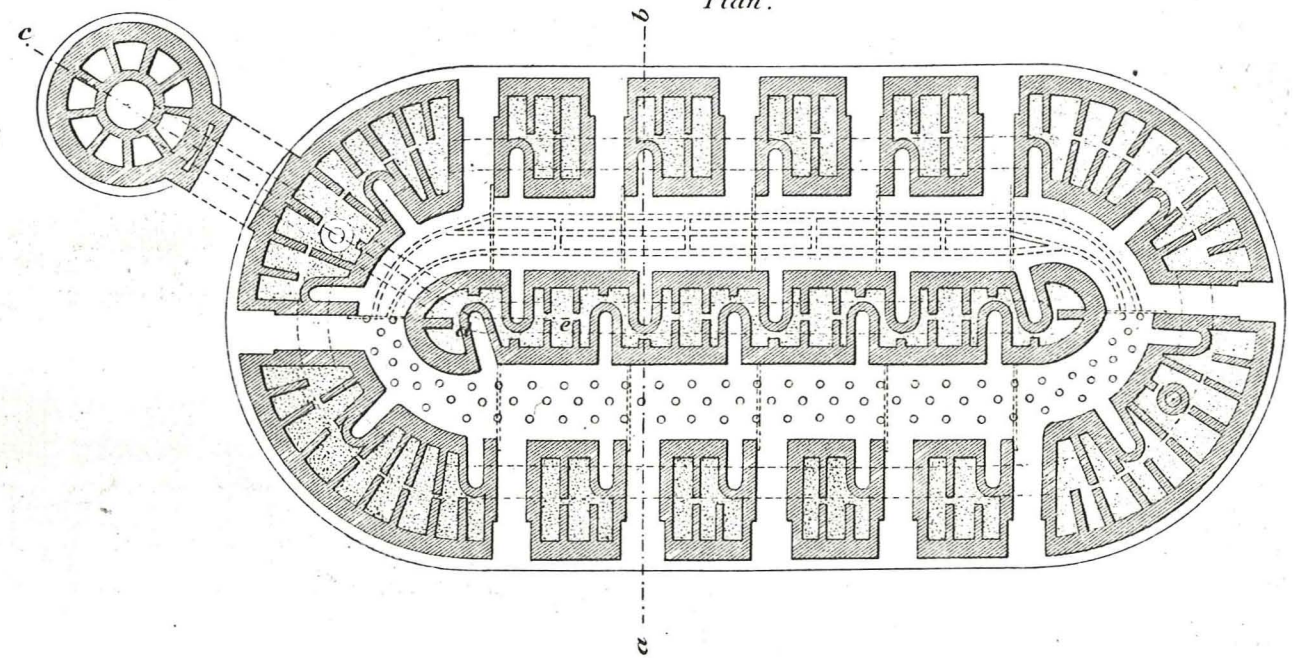

fig 2 a  
1:100

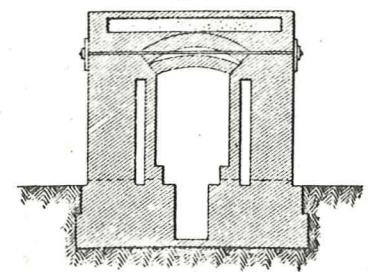

fig 2 b  
1:20

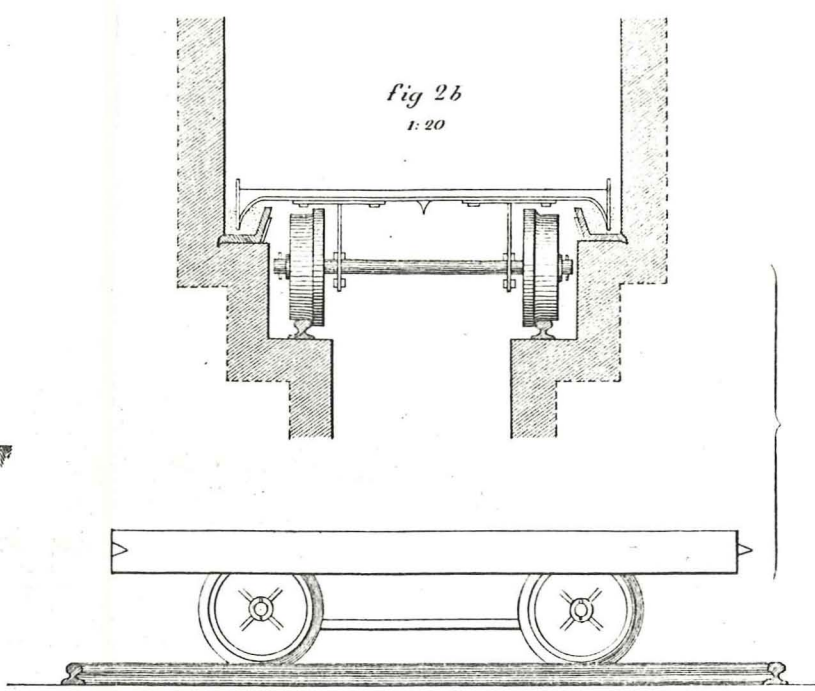
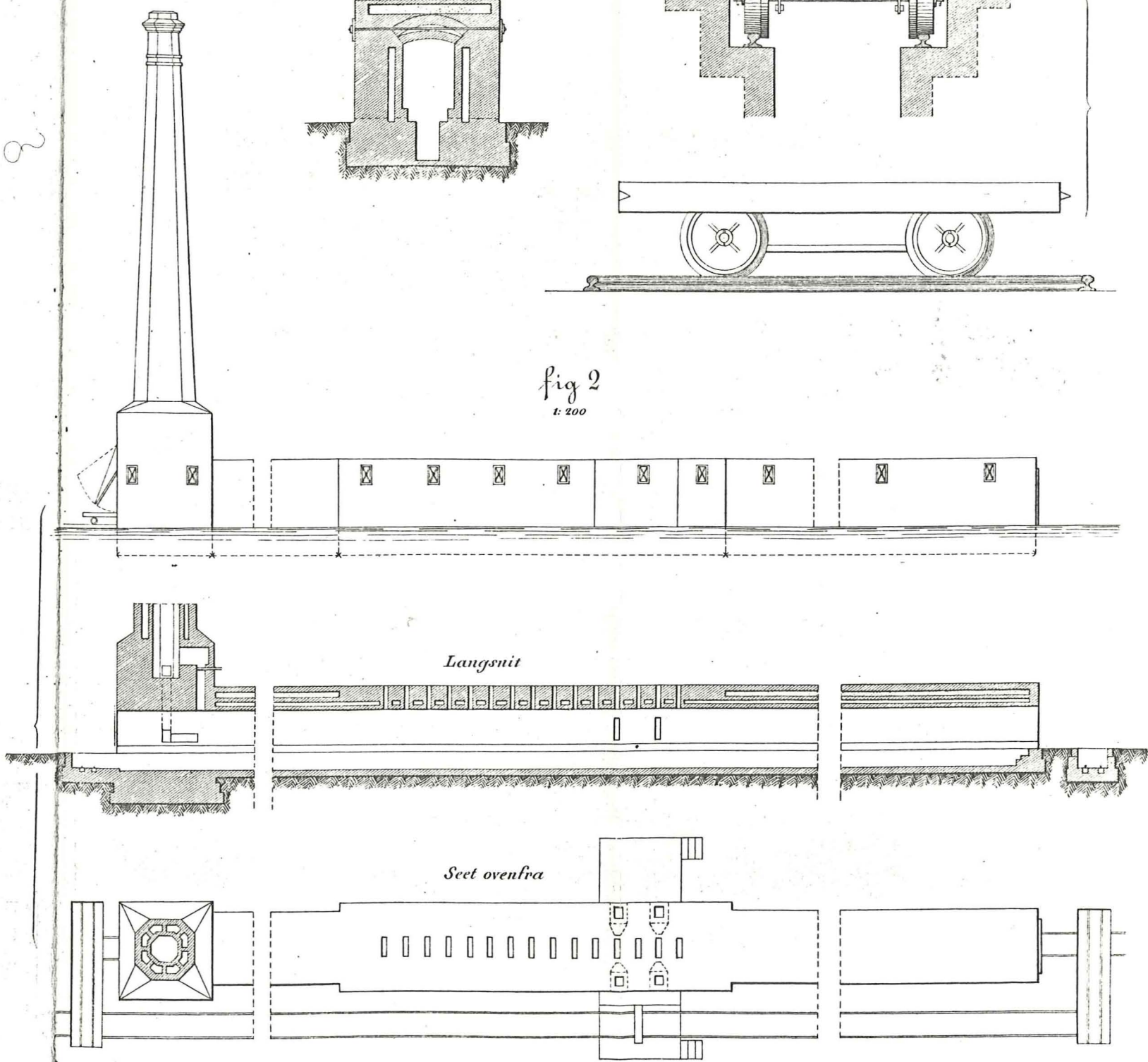

fig 2  
1:200





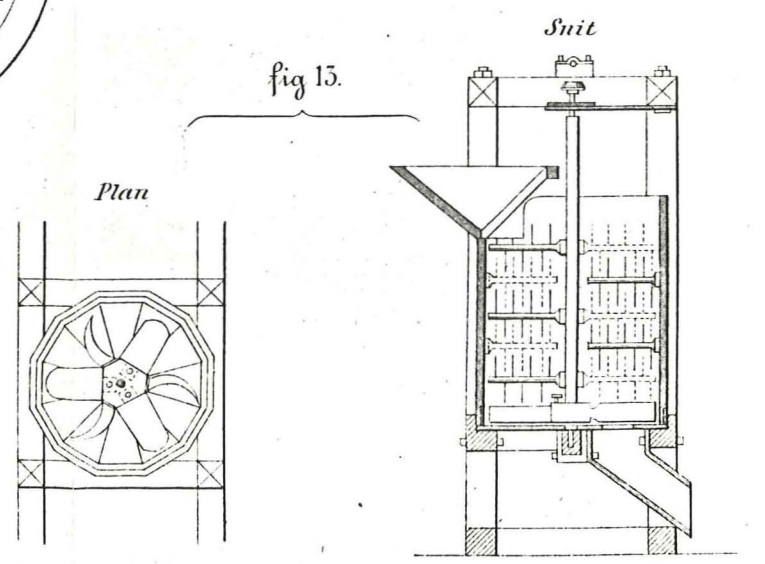
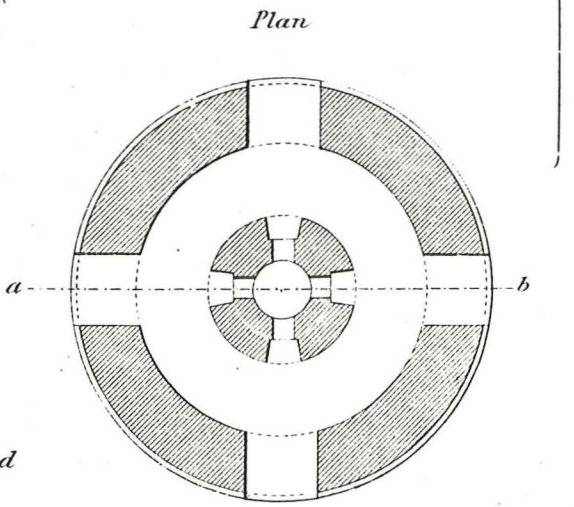
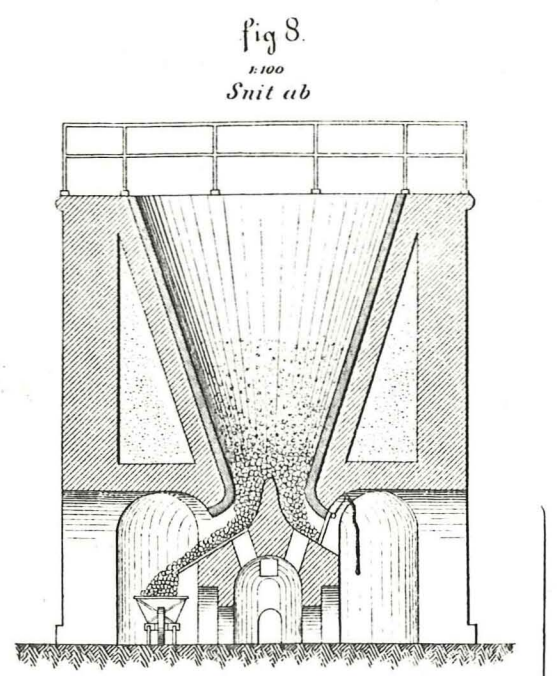
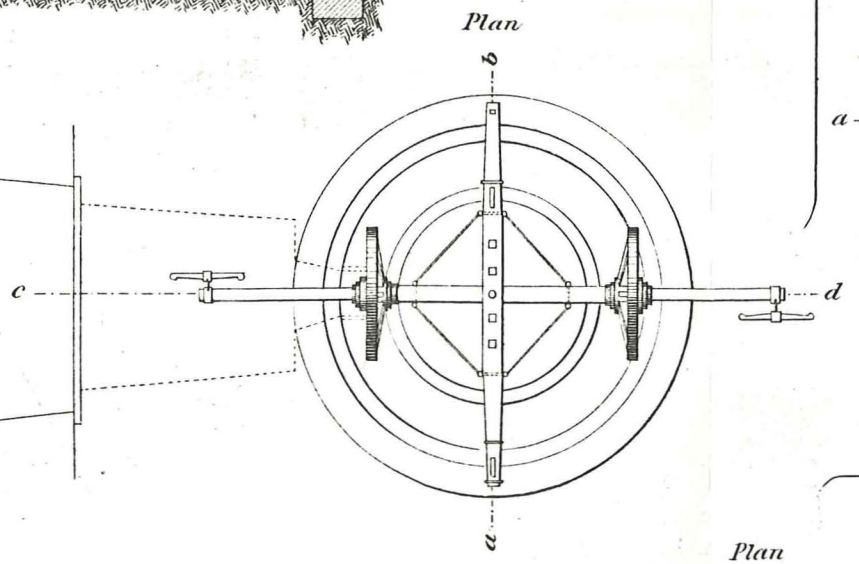
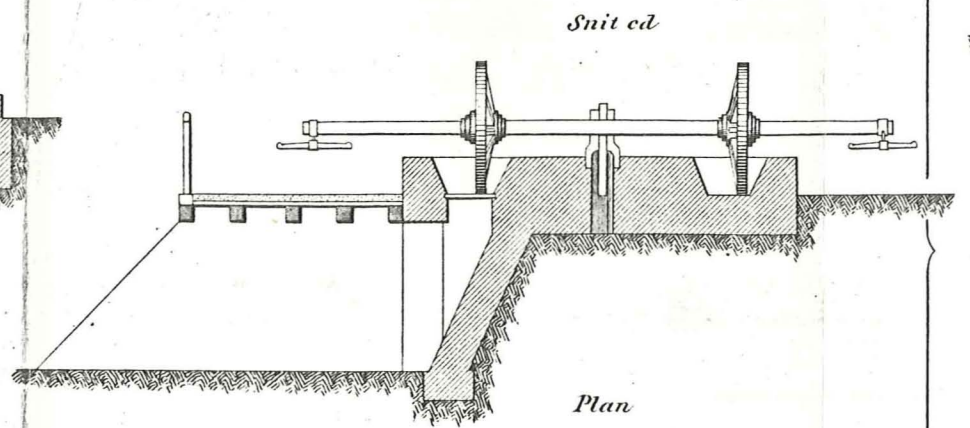
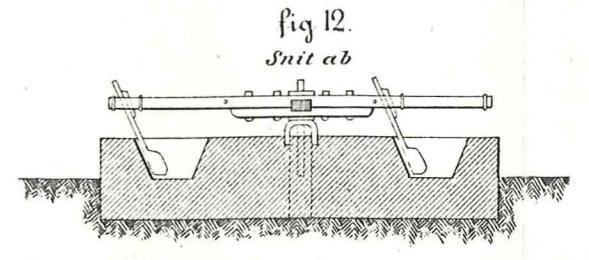
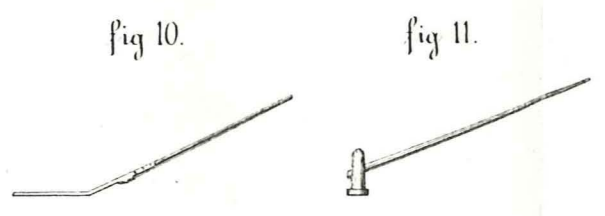
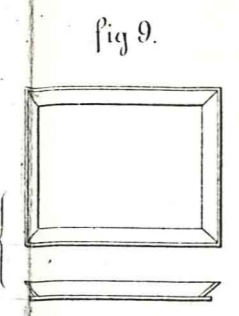
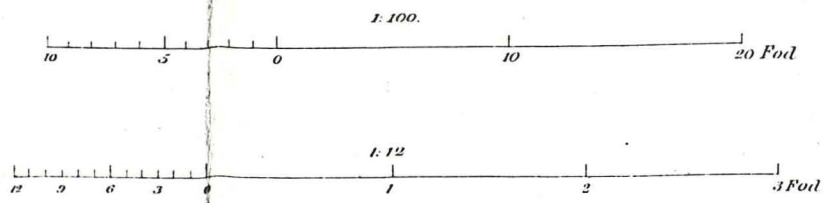
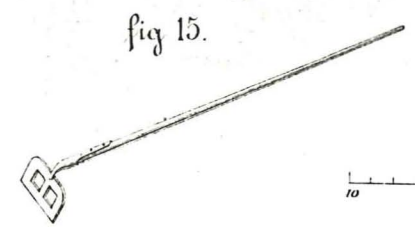
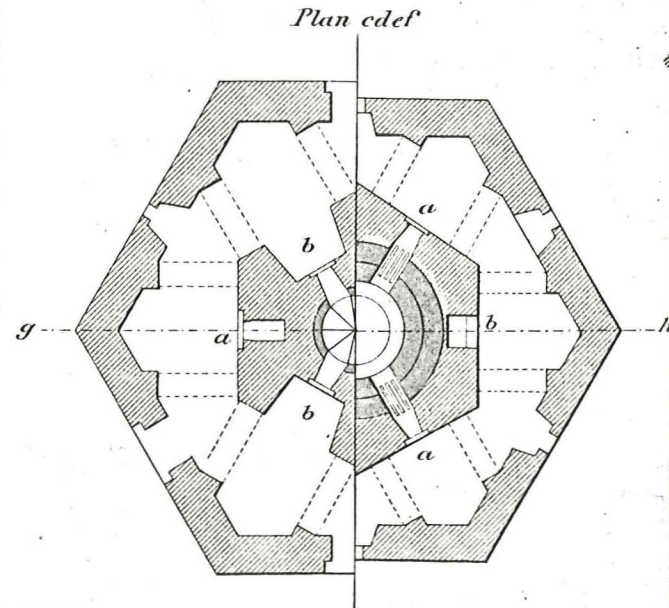
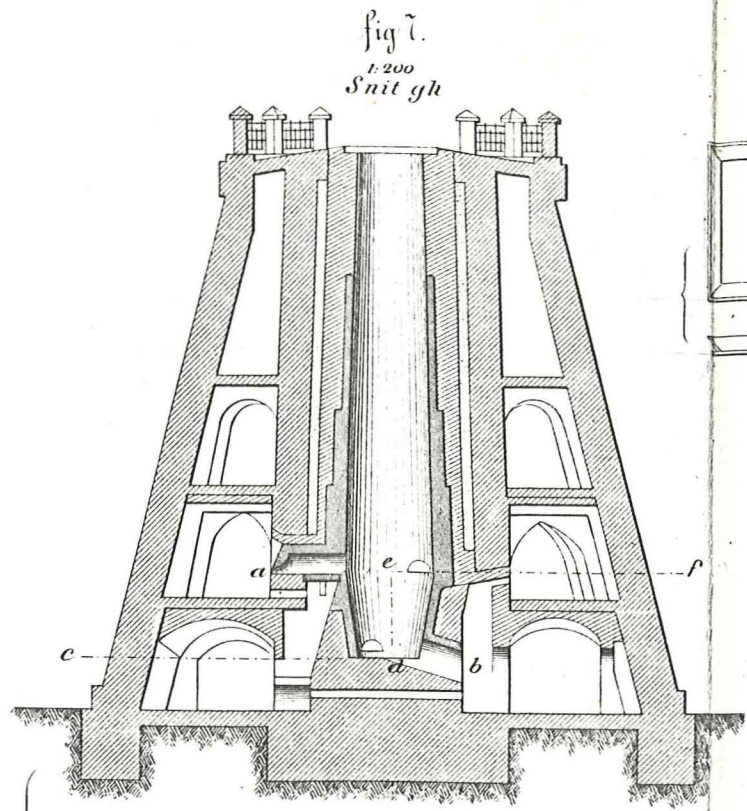
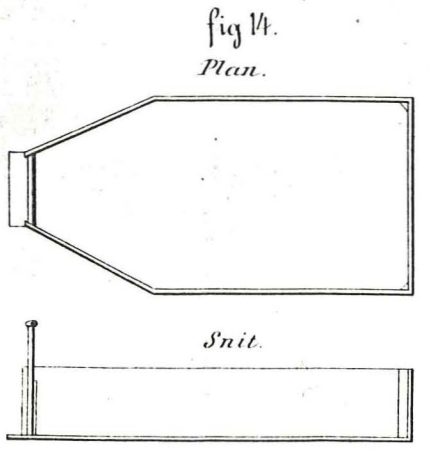
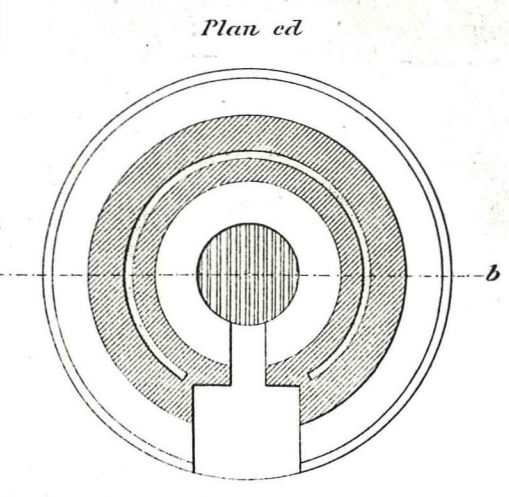
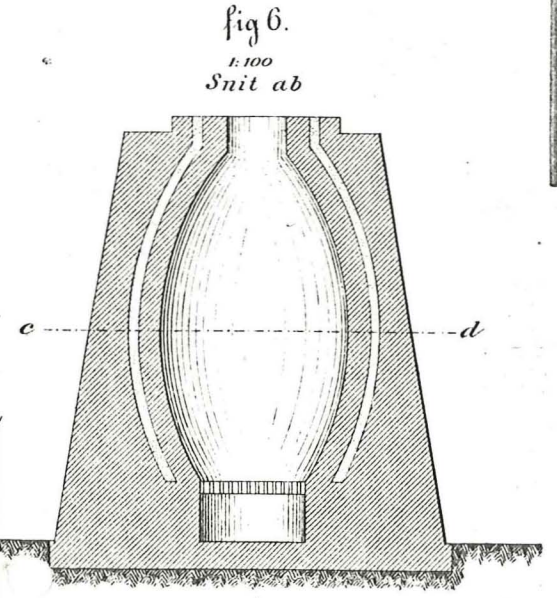
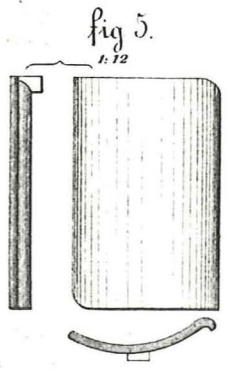
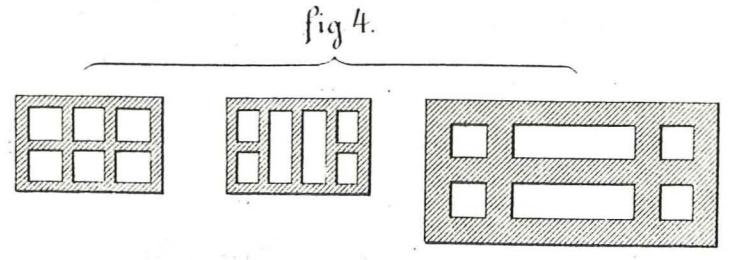
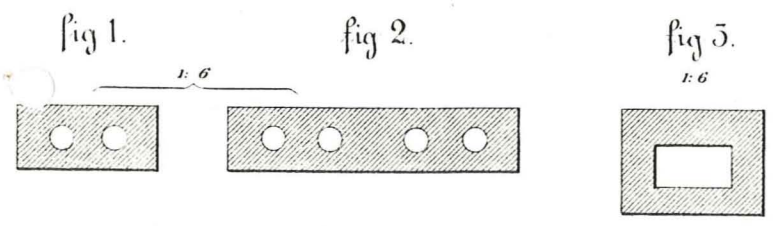



fig 1.

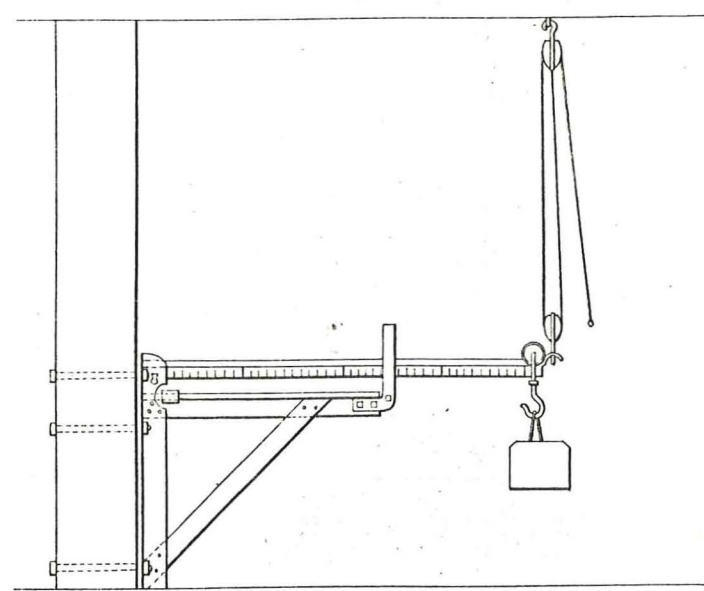

fig 2

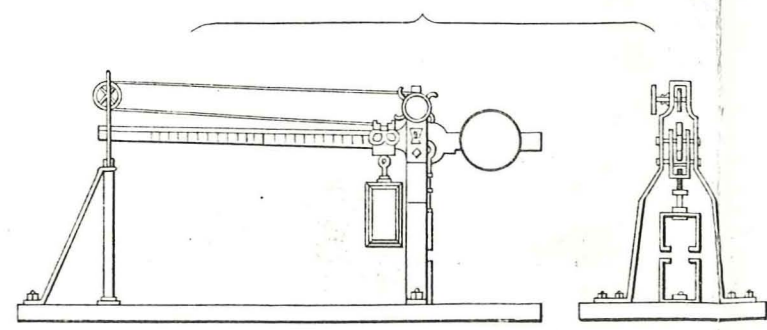

fig 6.

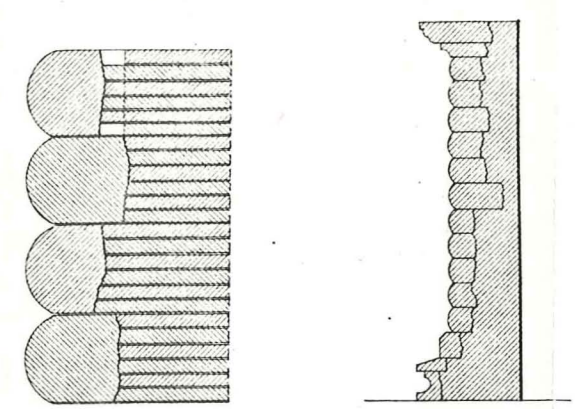

fig 8.

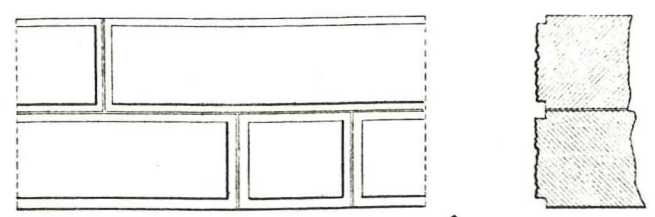

fig 5

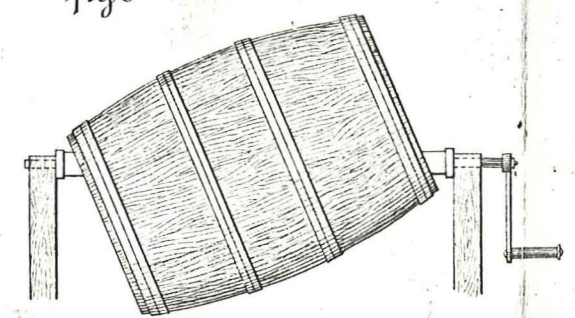

fig 7.

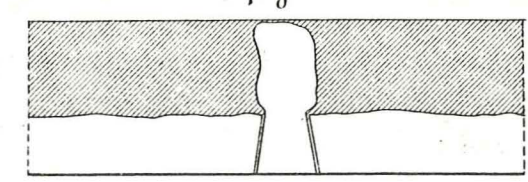

fig 9.

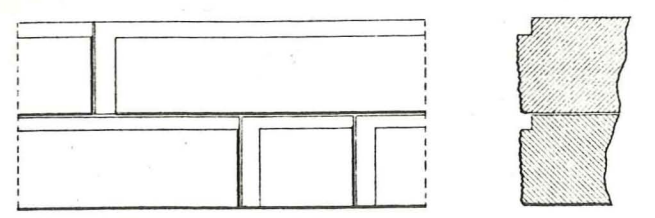

fig 3.

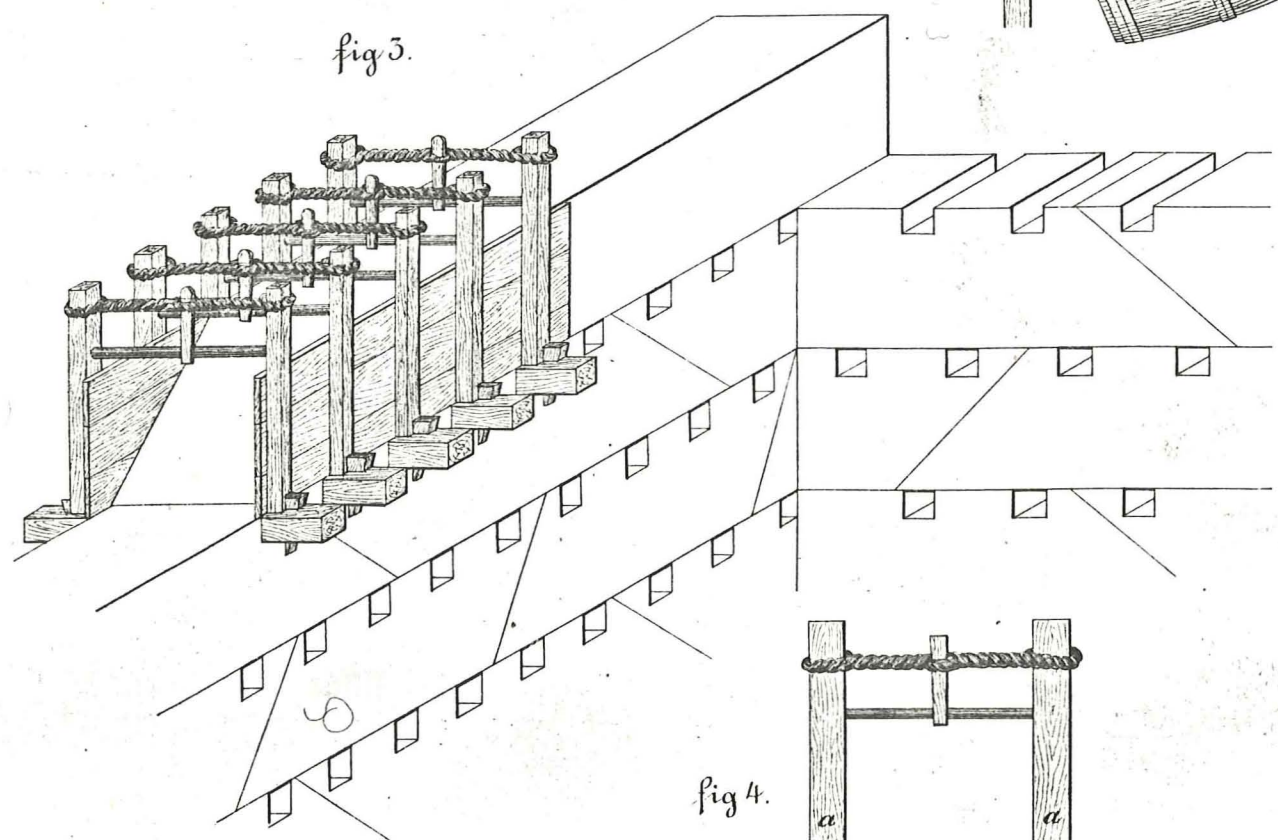

fig 12.

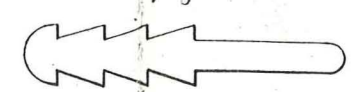

fig 11.

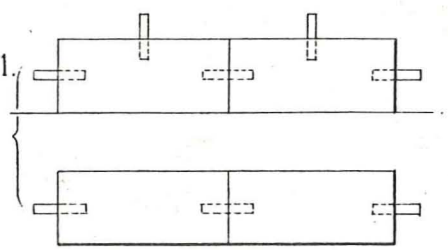

fig 10.

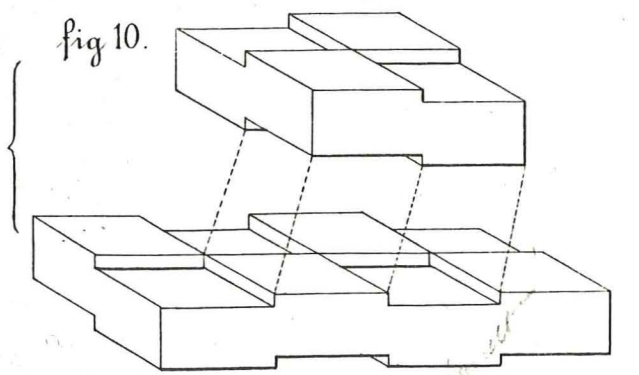

fig 15.

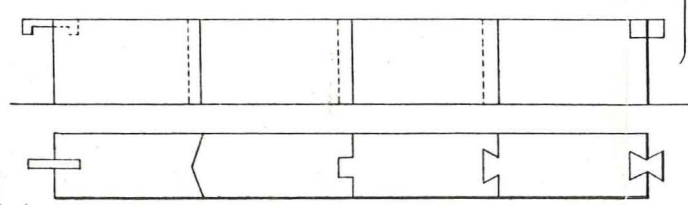
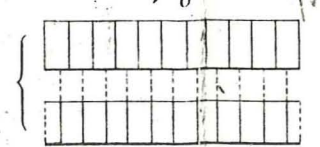

fig 18.

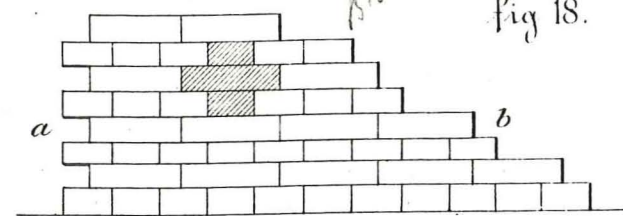

fig 16.

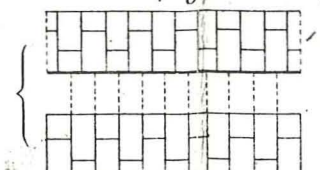

fig 13.

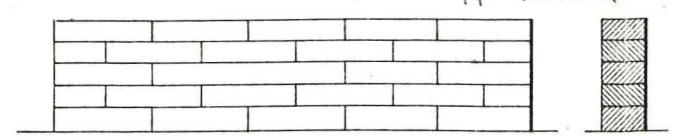

fig 19.

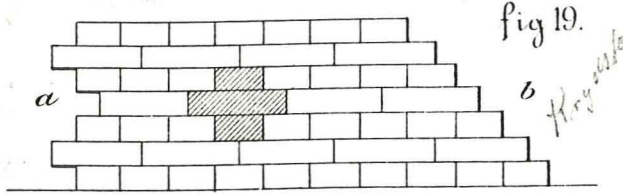

fig 17.

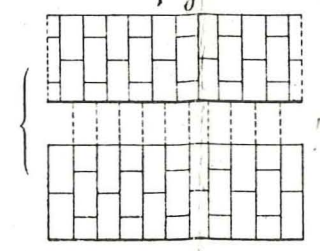

fig 14.

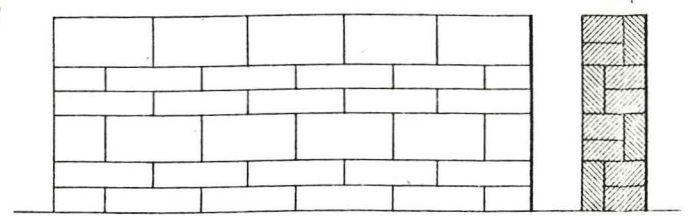

fig 20.

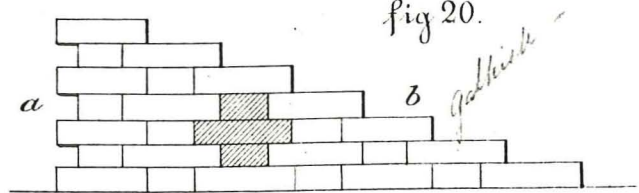

fig 4.

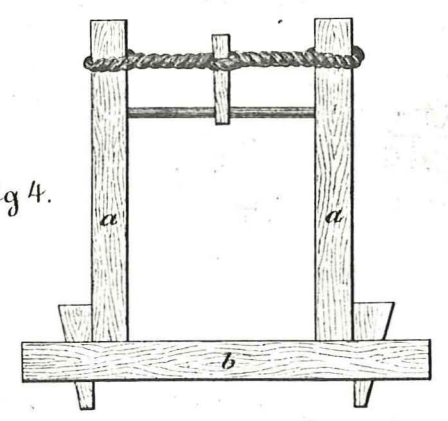



fig. 1.

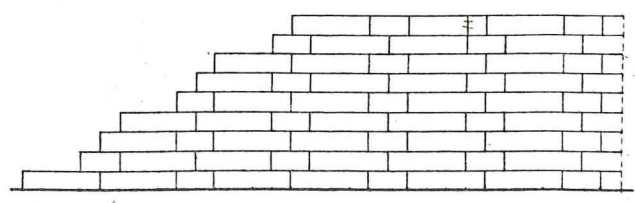

fig. 5.

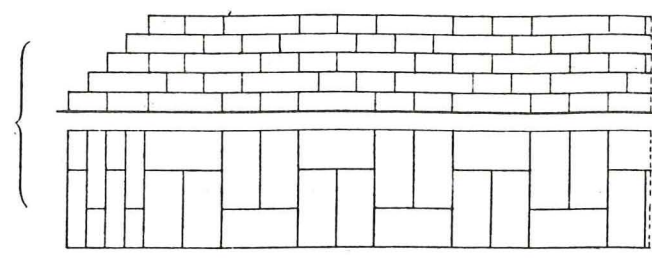

fig. 9.  
a.

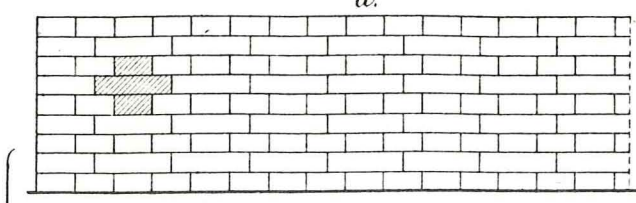

fig. 10.  
a.

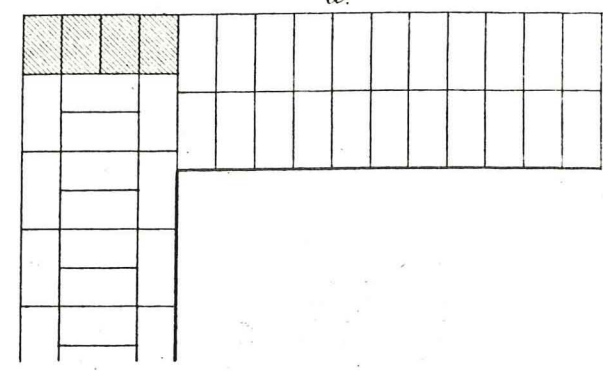

fig. 2.

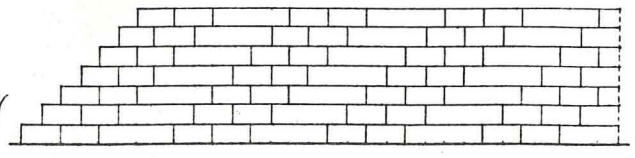
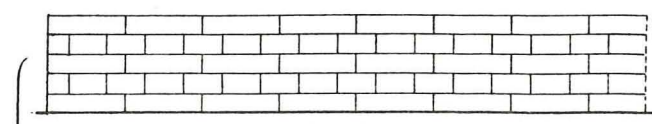
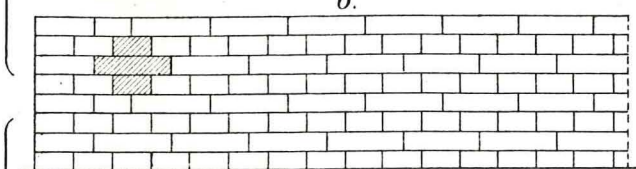

fig. 6.



b.



b.

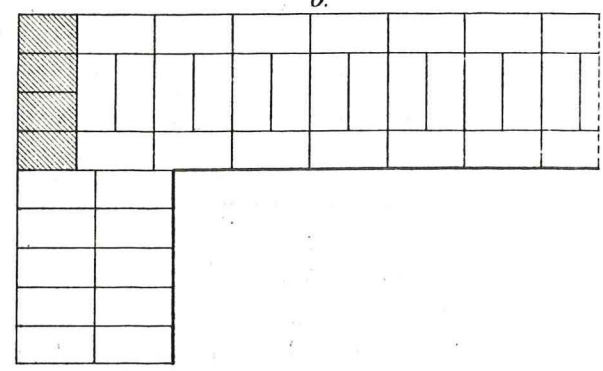

fig. 3 a.

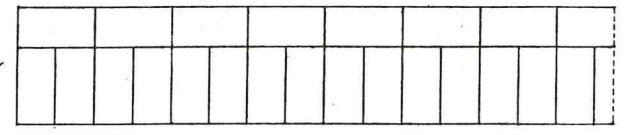
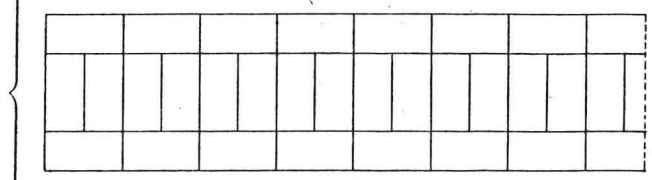

fig. 7.



c.

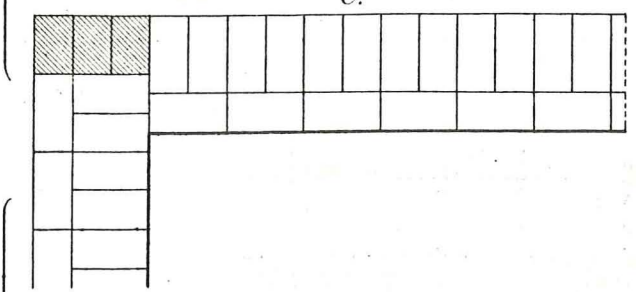

fig. 11.  
a.

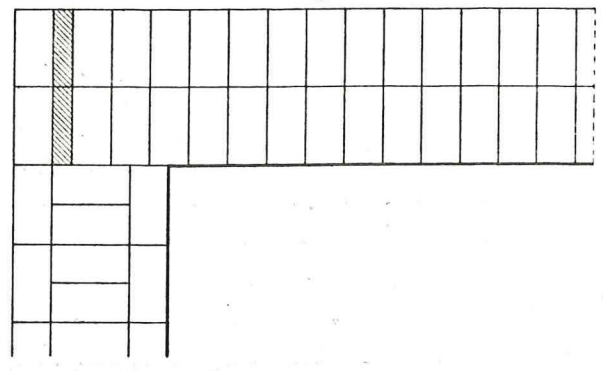

fig. 3 b.

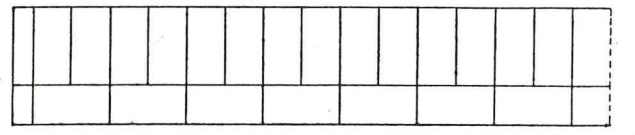
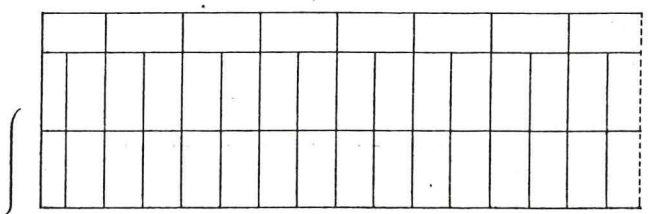
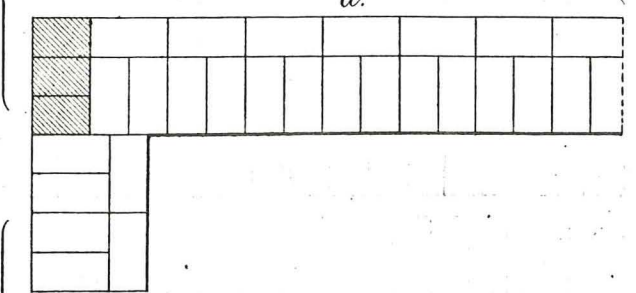

fig. 8.



d.



e.

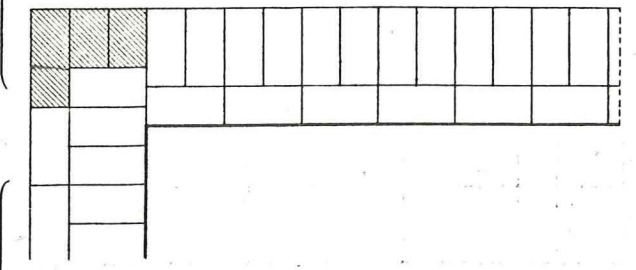

f.

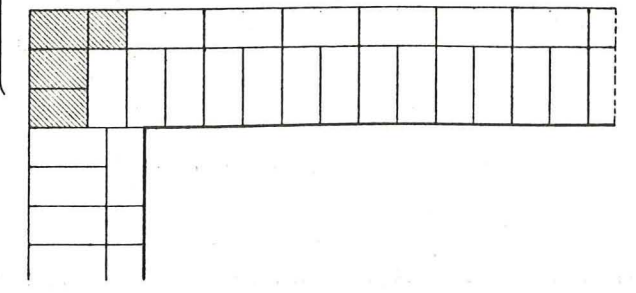

b.

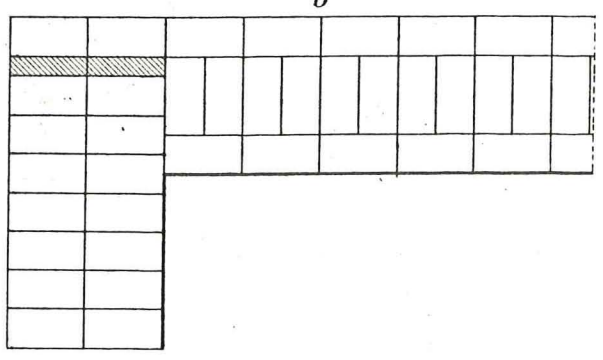

fig. 4.

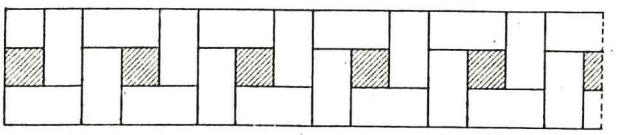
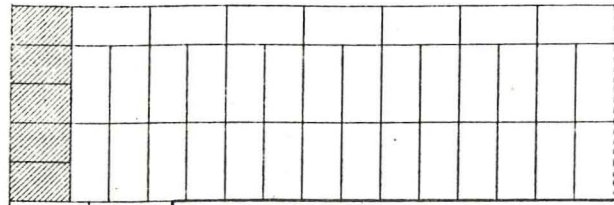

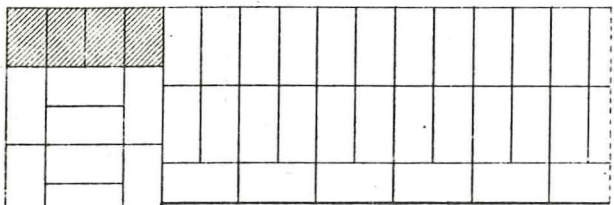

fig. 1.

a



b



c

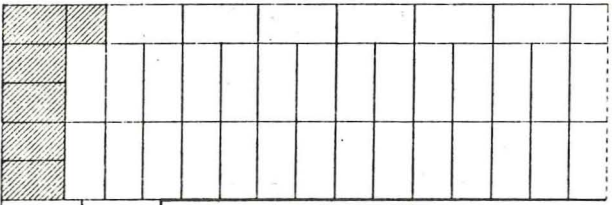

d

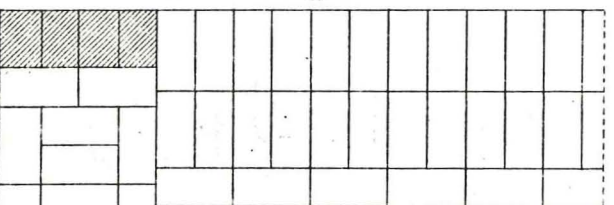
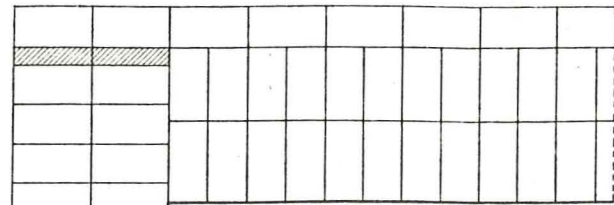
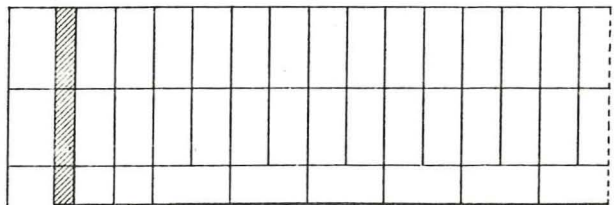

fig. 2.

a



b



c

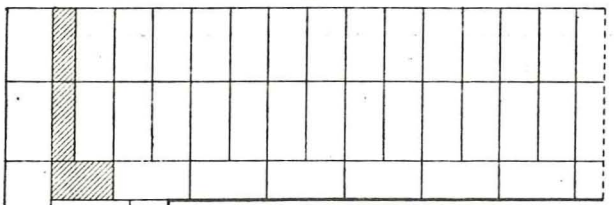

d

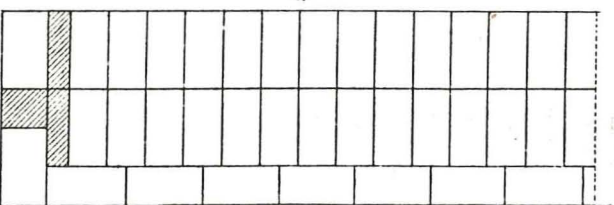
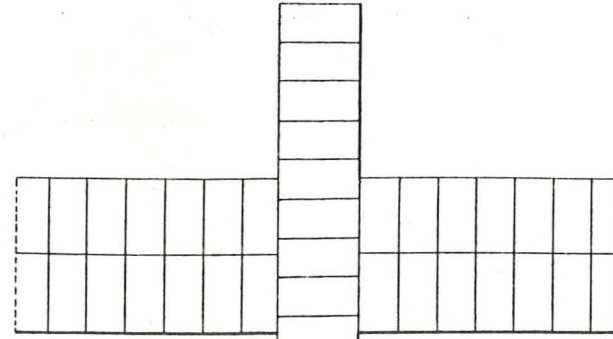
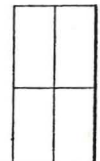

fig. 3.

a



b



c

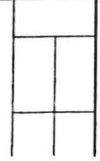
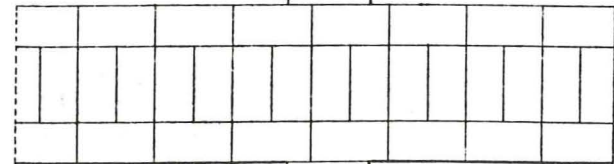
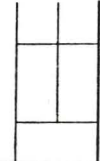
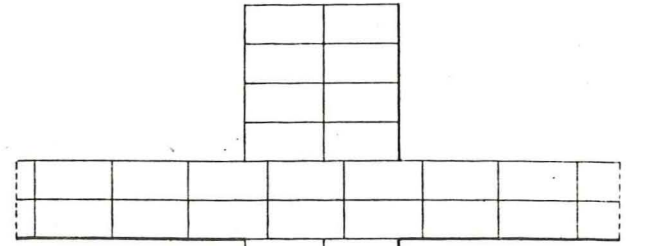
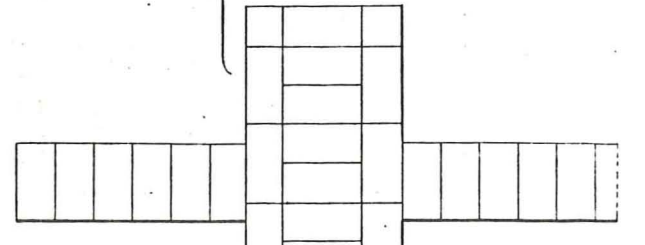

fig. 4.

a



b



c

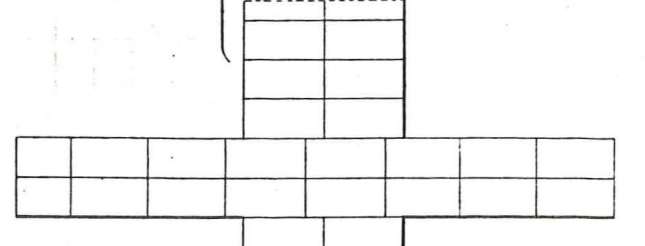

d

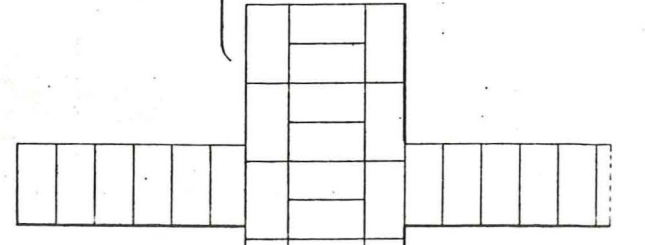



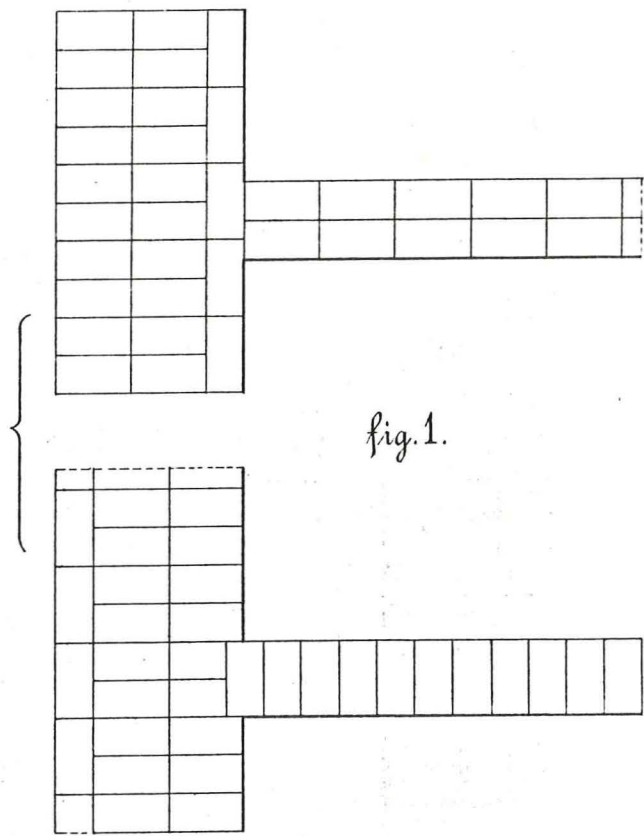

fig. 1.

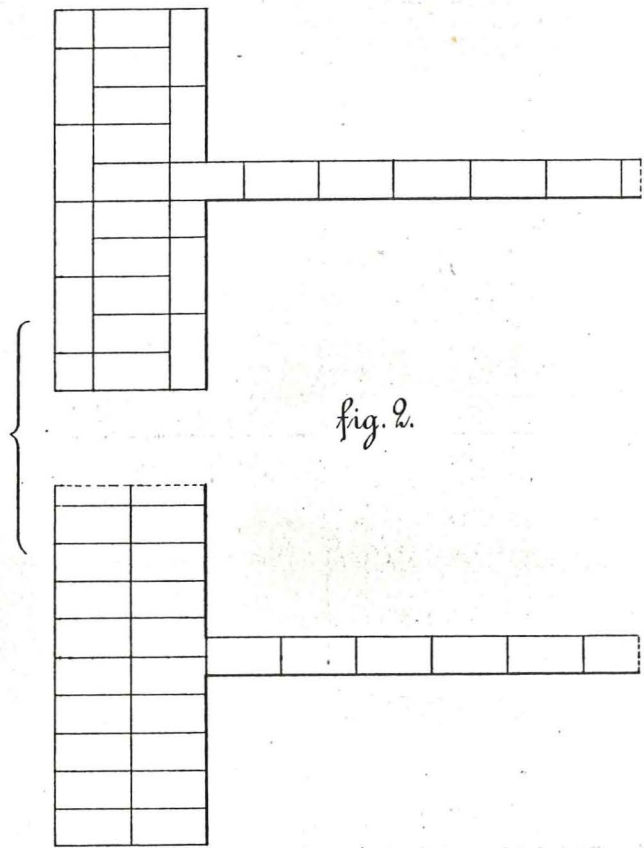

fig. 2.

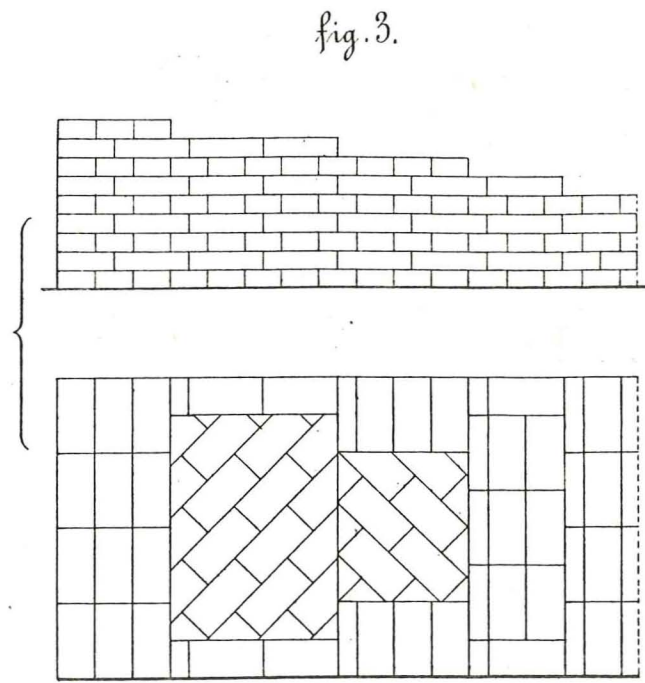

fig. 3.

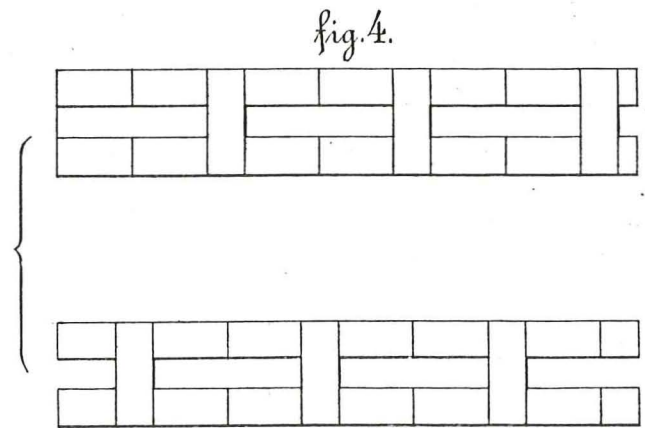

fig. 4.

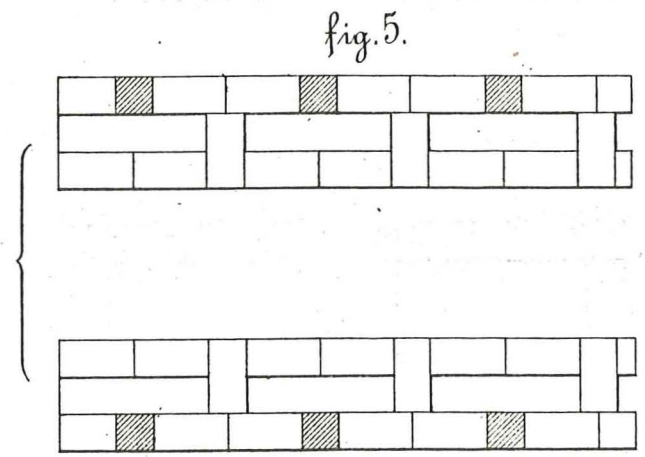

fig. 5.

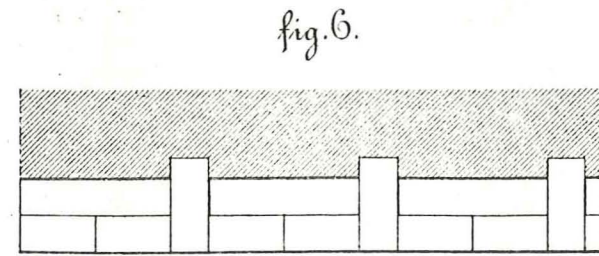

fig. 6.

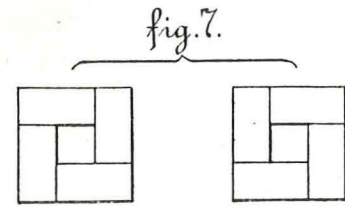

fig. 7.

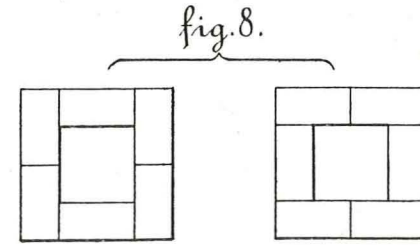

fig. 8.

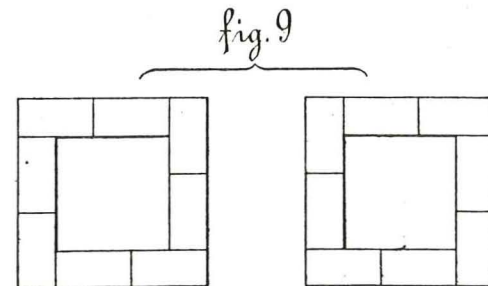

fig. 9.

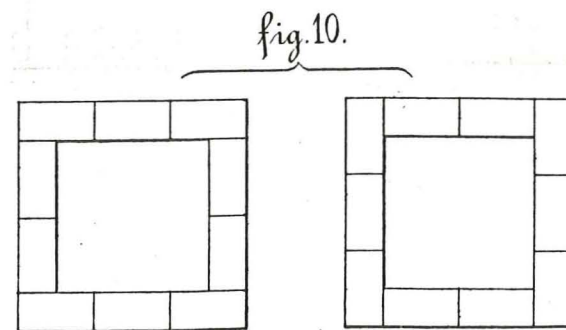

fig. 10.

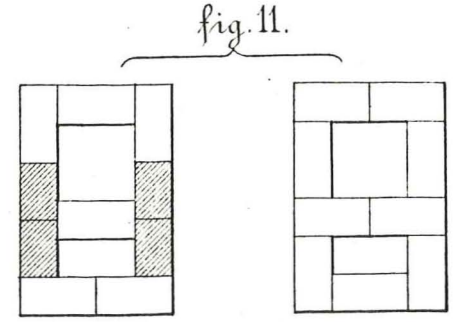

fig. 11.

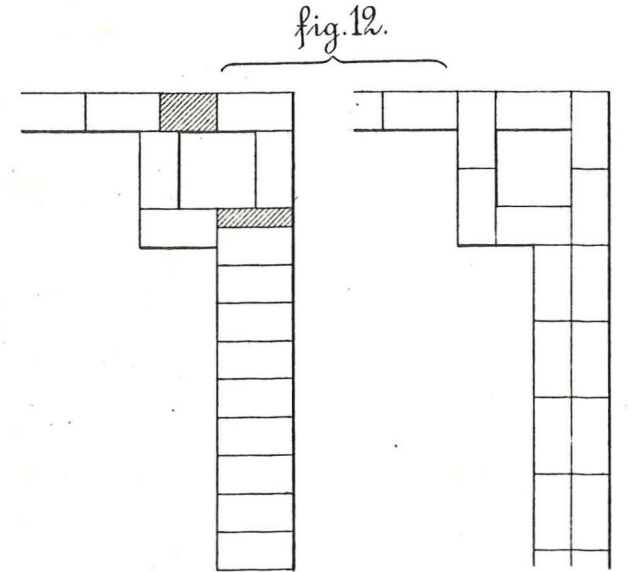

fig. 12.

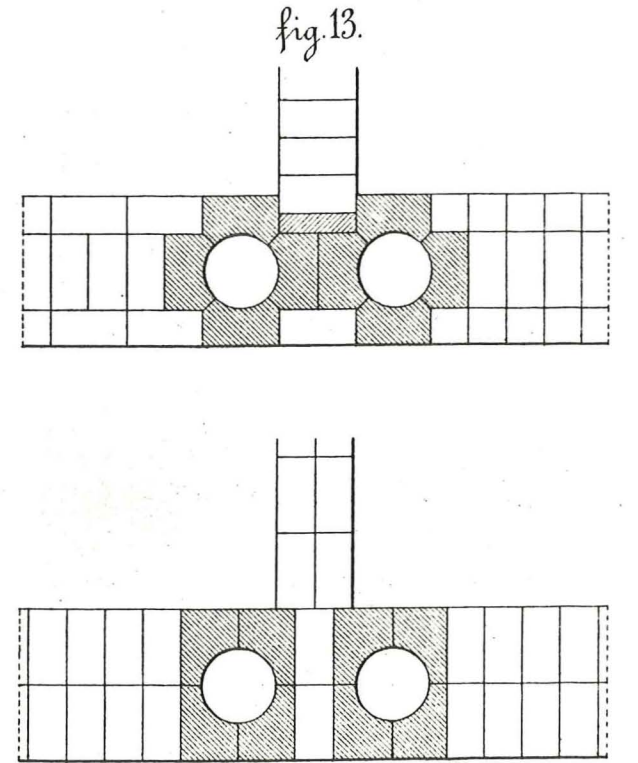

fig. 13.



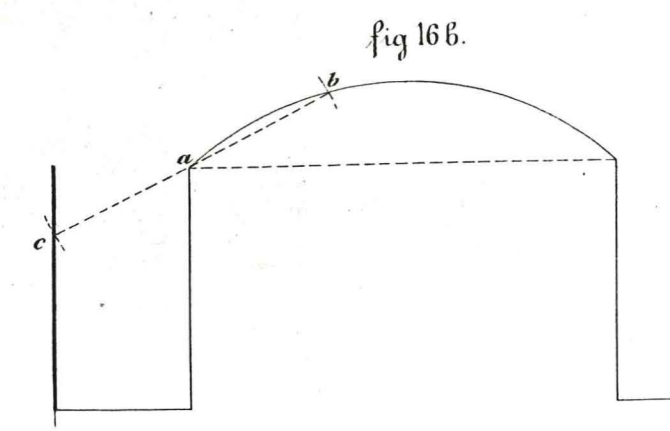
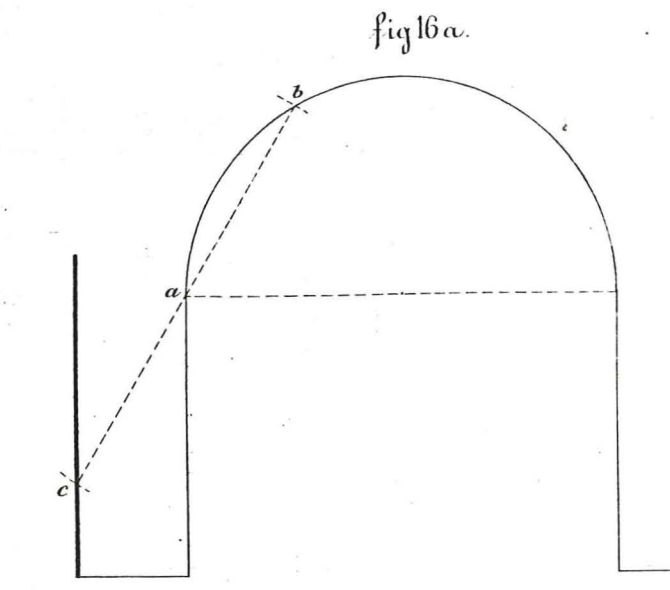
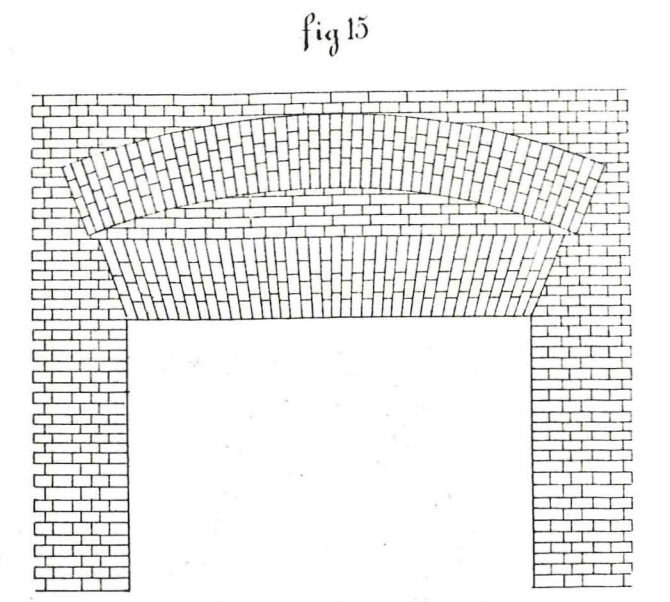
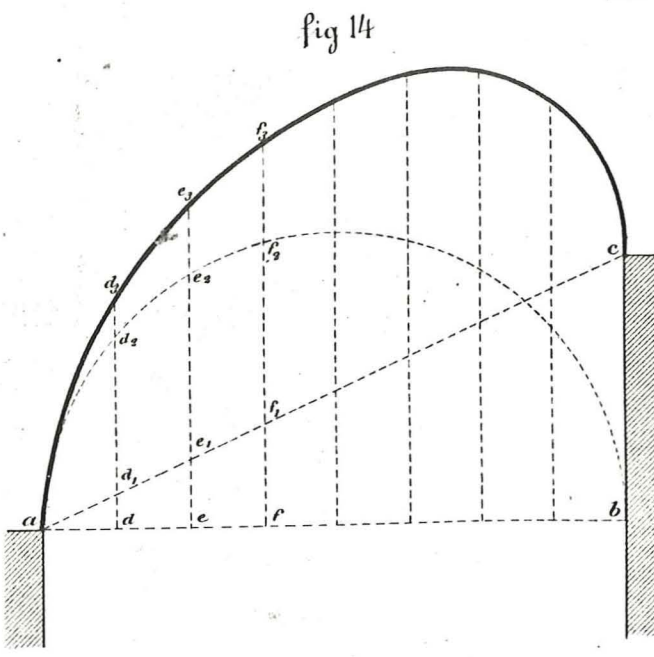
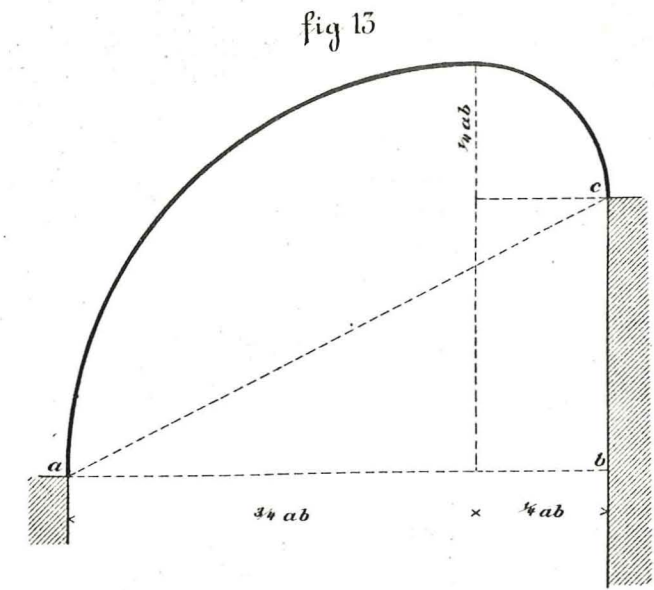
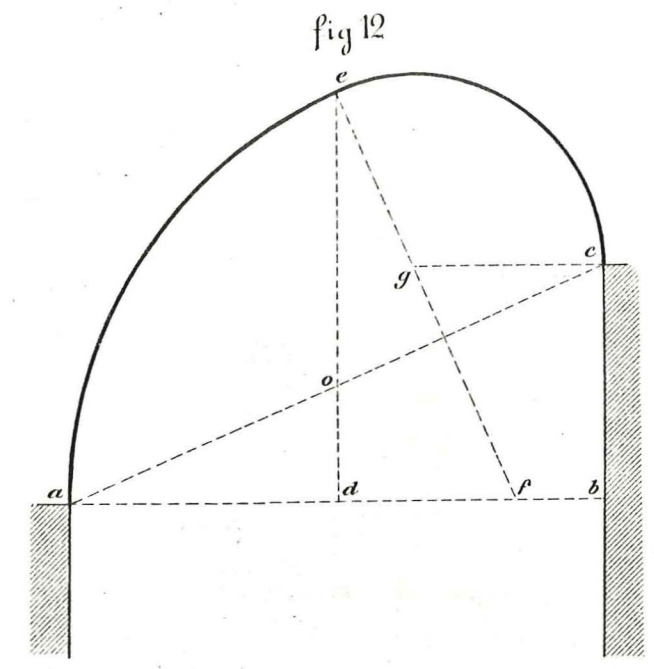
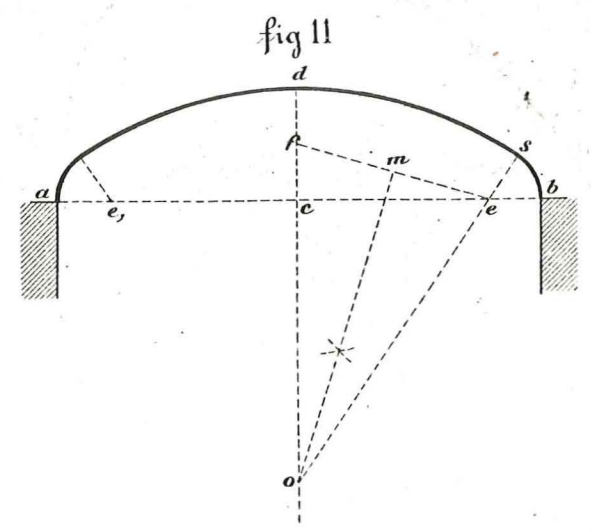
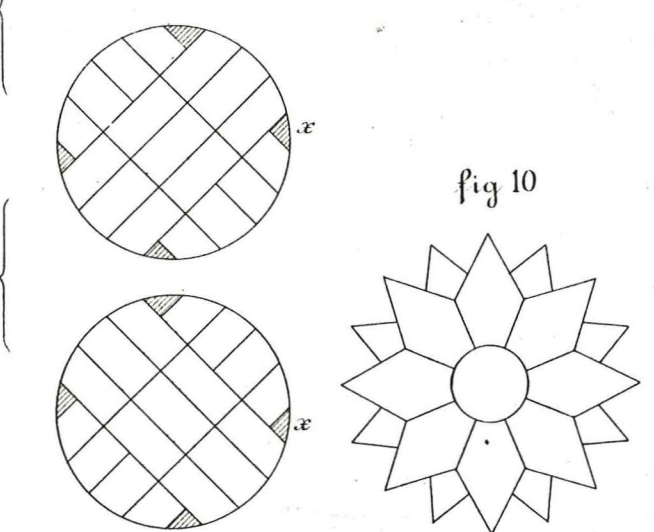
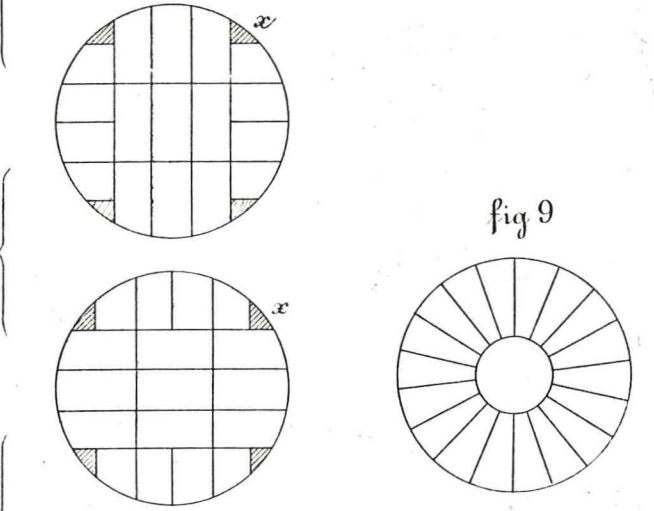
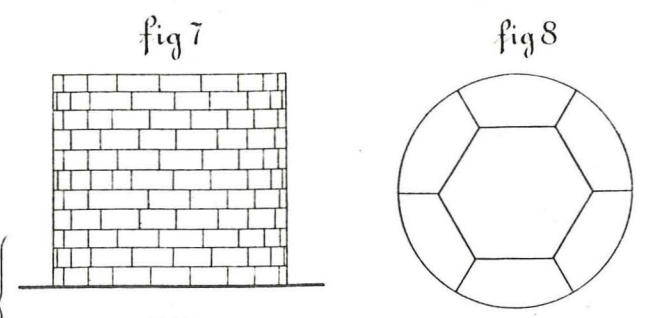
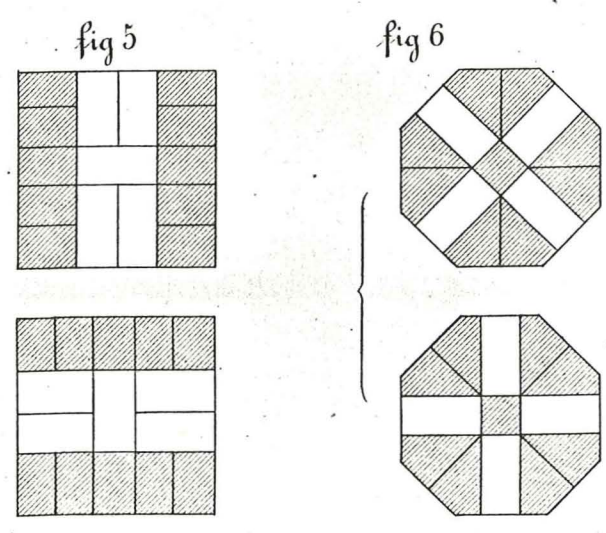
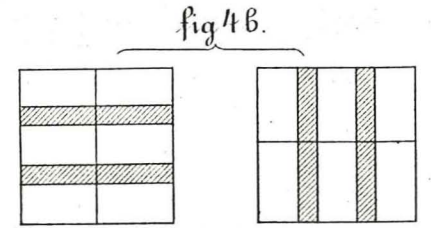
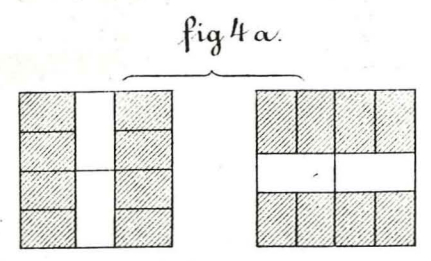
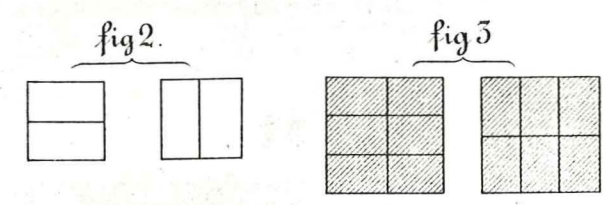
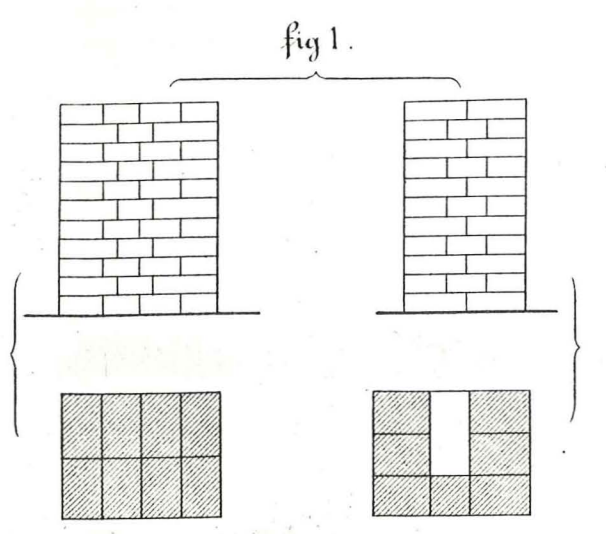



fig. 1.

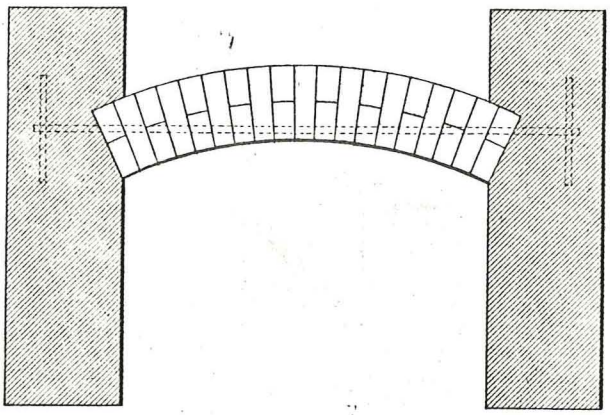

fig. 3.

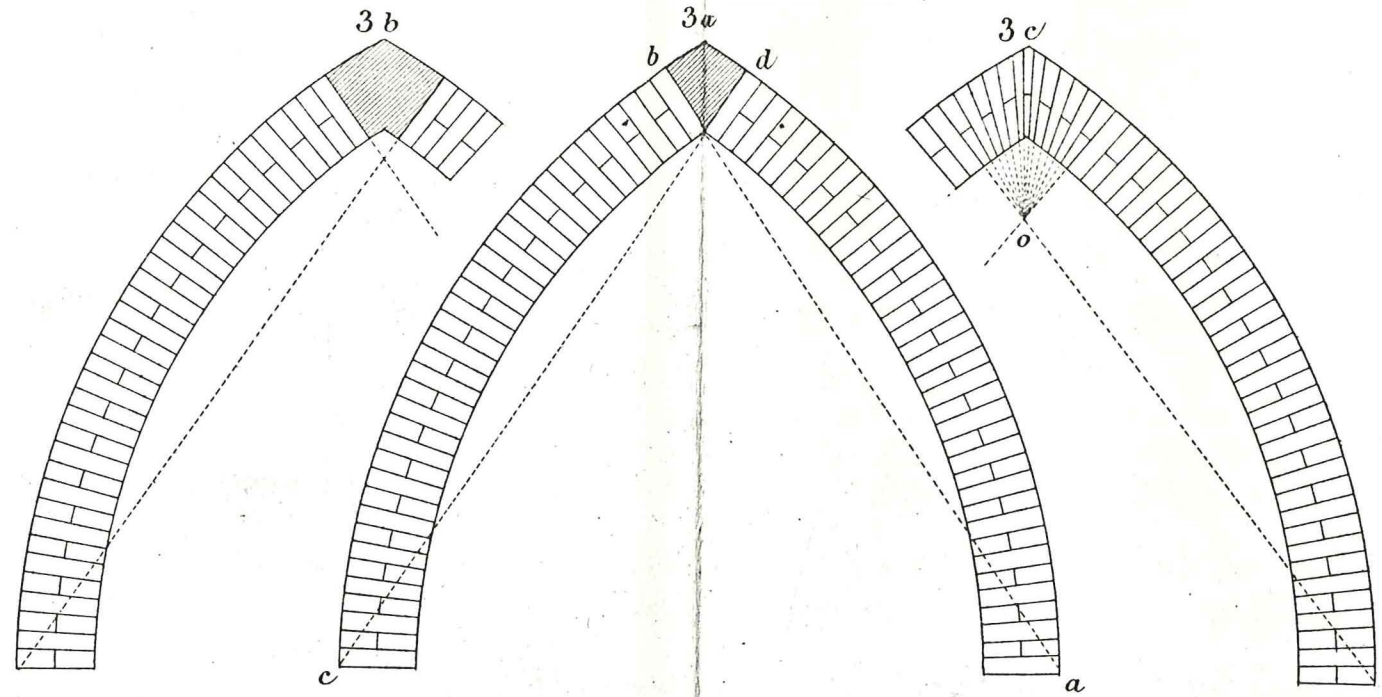

fig. 7.

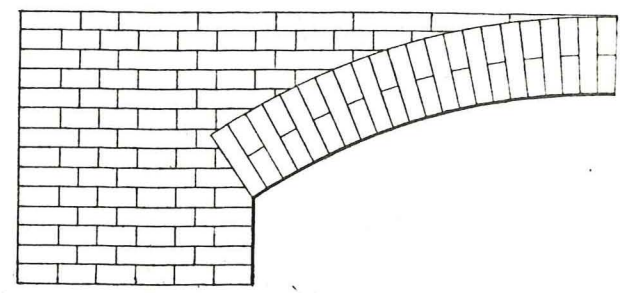

fig. 2.

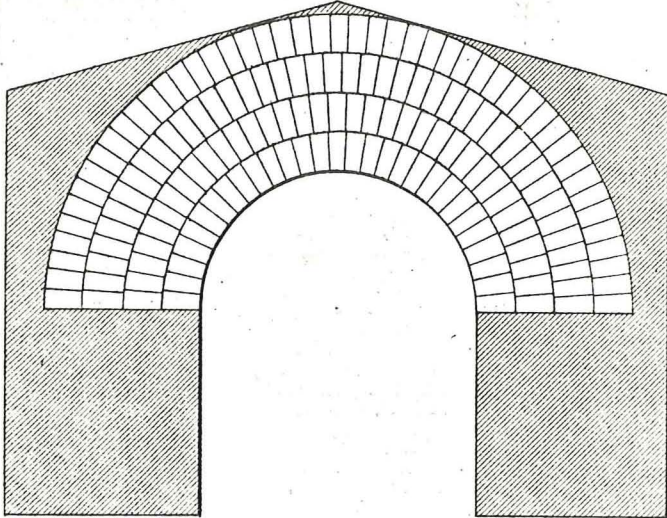

fig. 8.

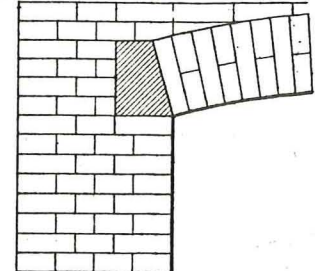

fig. 9.

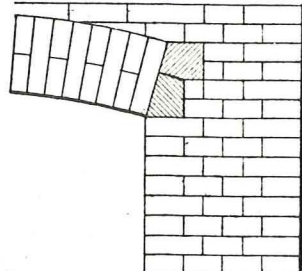

fig. 10.

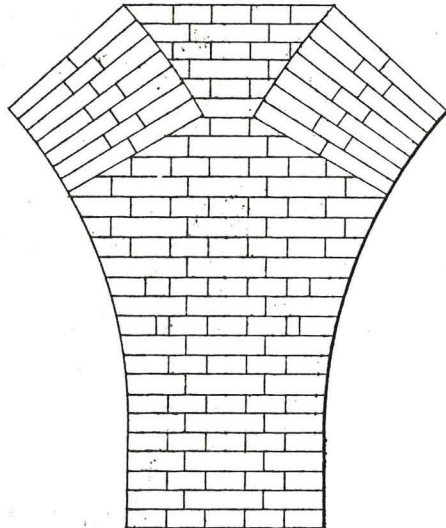

fig. 4.

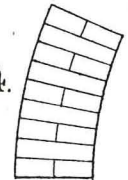

fig. 4 a.

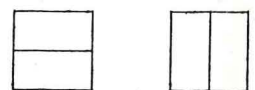

fig. 4 b.

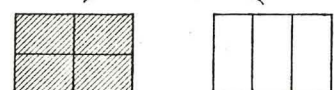

fig. 4 c.

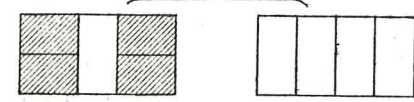

fig. 4 d.

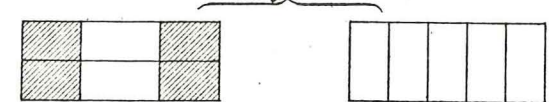

fig. 5 a.

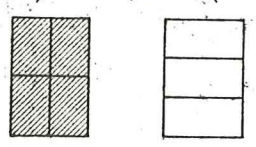

fig. 5 b.

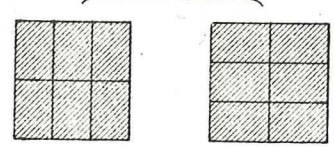

fig. 5 c.

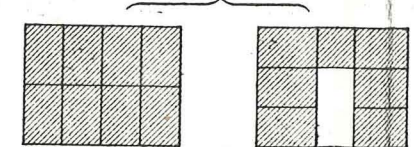

fig. 5 d.

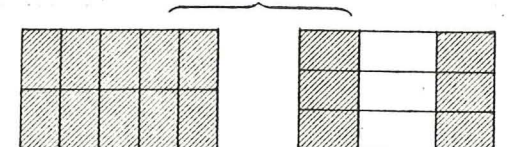

fig. 6 a.

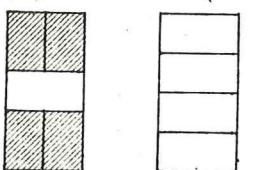

fig. 6 b.

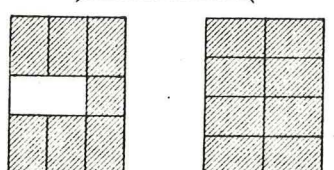

fig. 6 c.

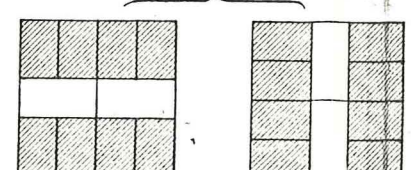

fig. 6 d.

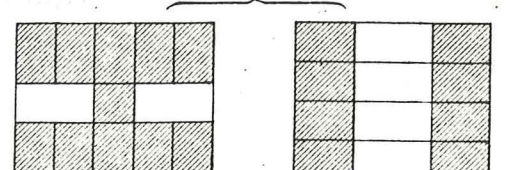

fig. 11.

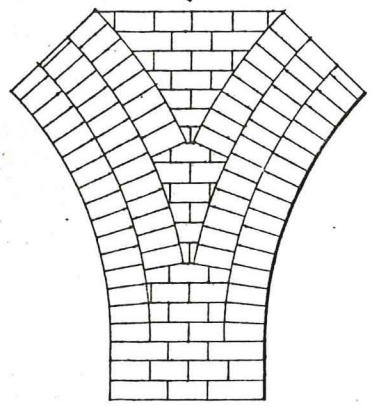

fig. 5

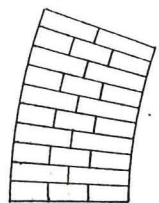

fig. 6

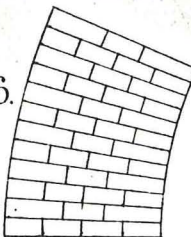



fig 1.

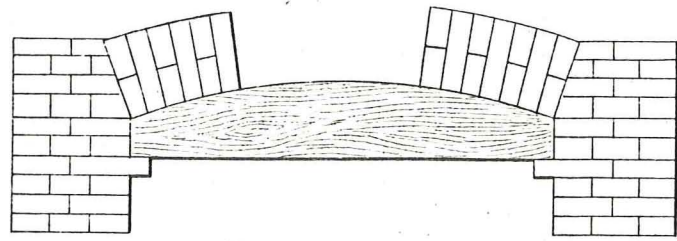

fig 2

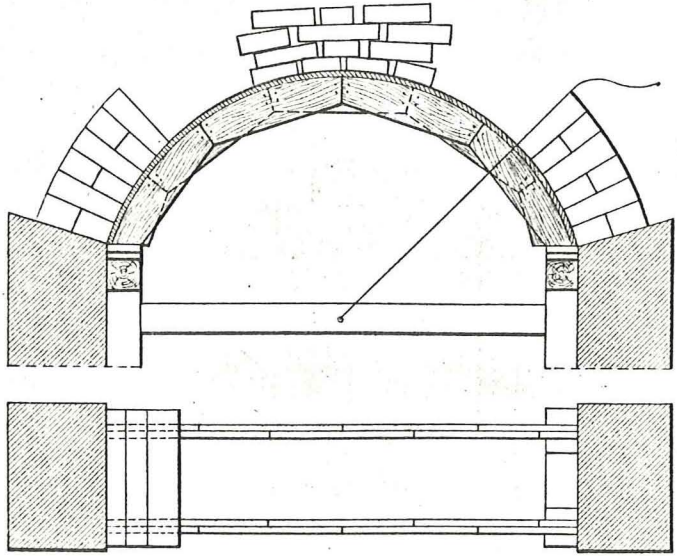

fig 3.

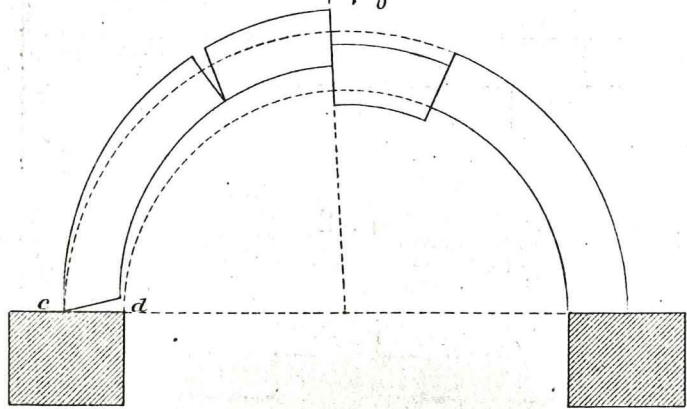
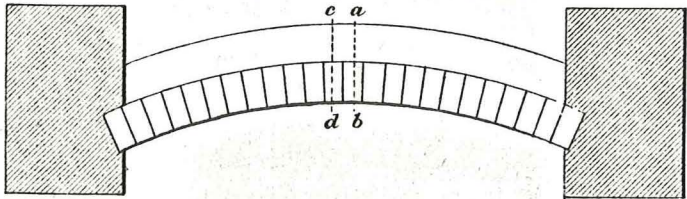
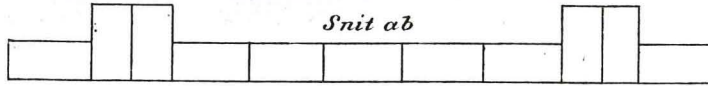

fig 4



Snit ab



Snit cd

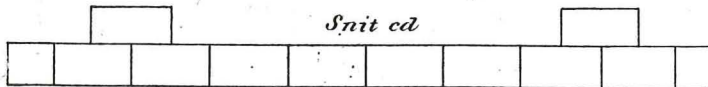
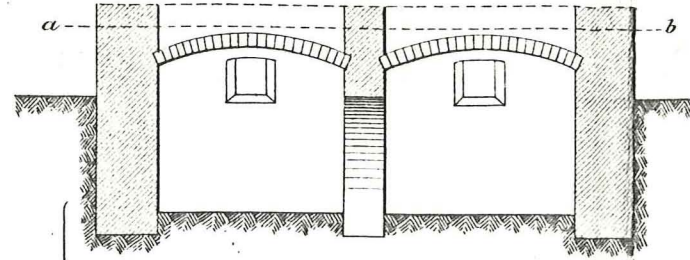

fig 5



Plan ab.

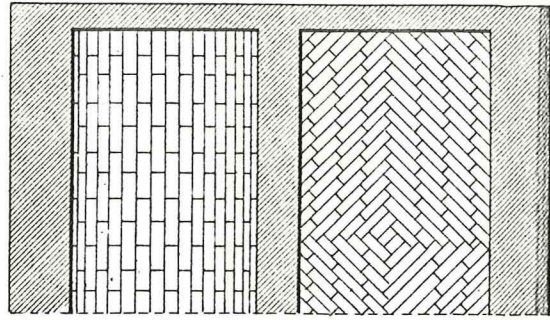

fig 6

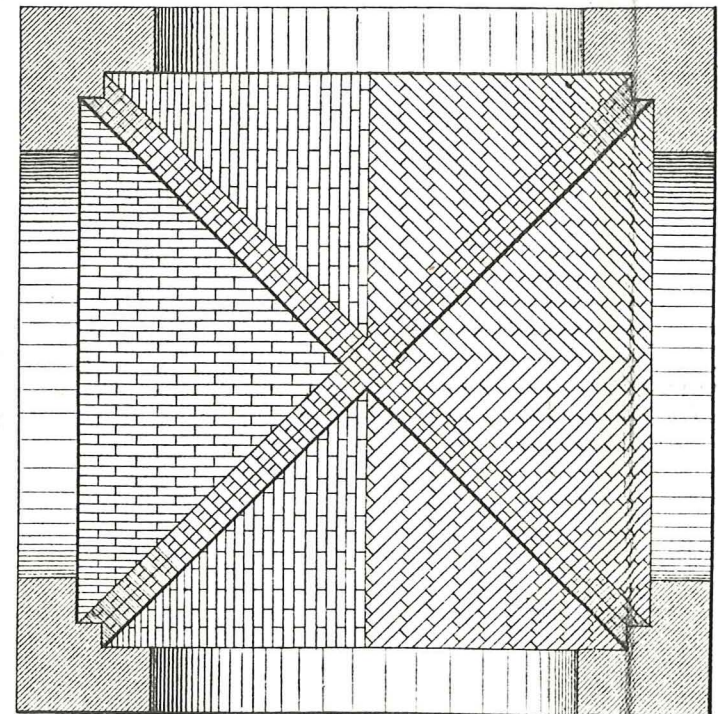
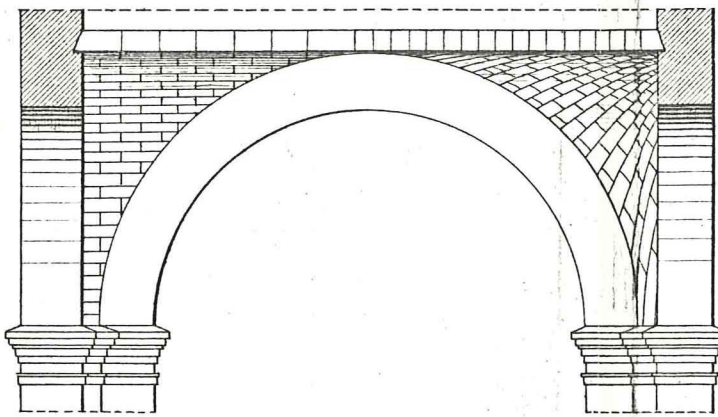

fig 7.

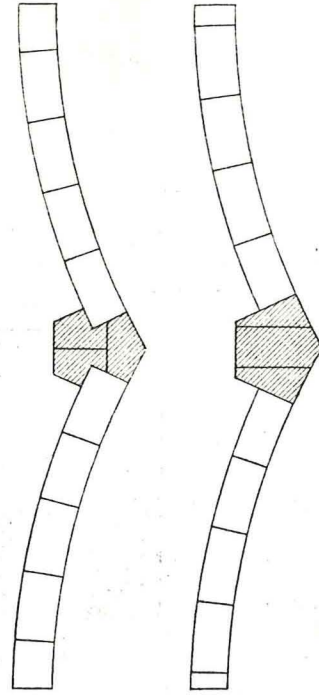

fig 9 a.

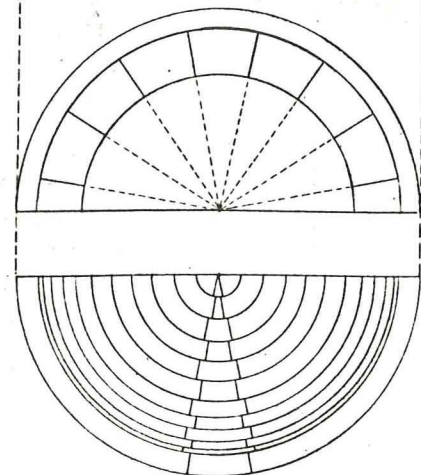
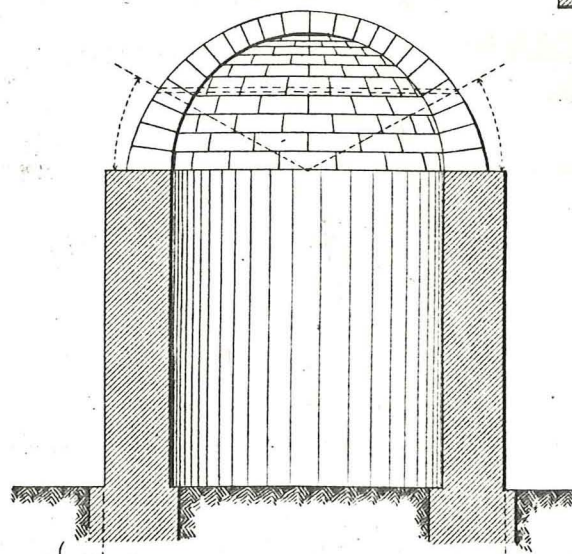

fig 8.

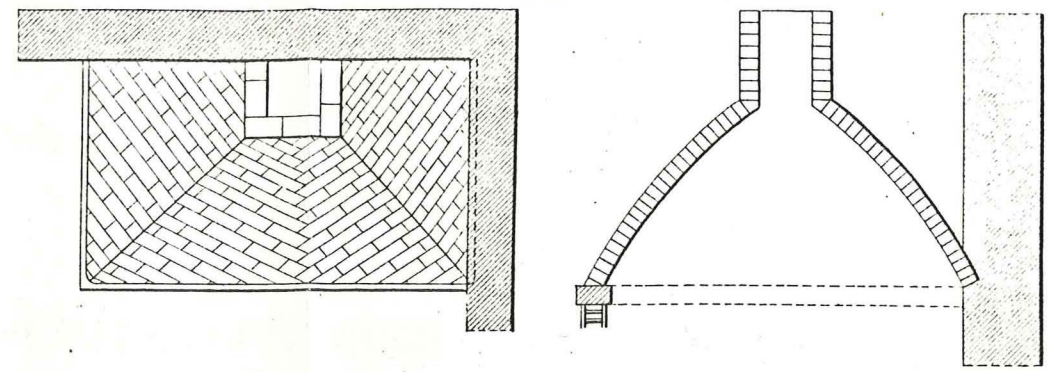

fig 9 b.

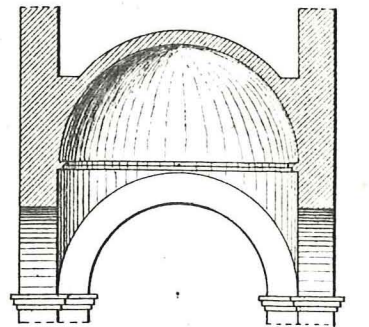
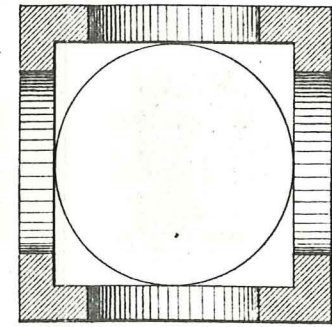

fig 10.

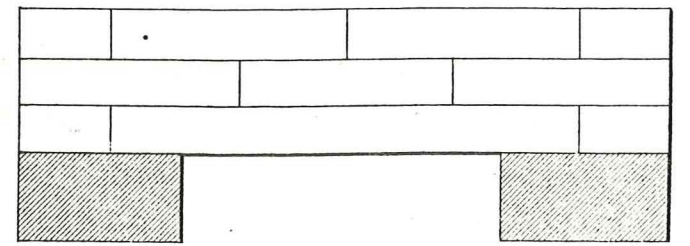

fig 11.

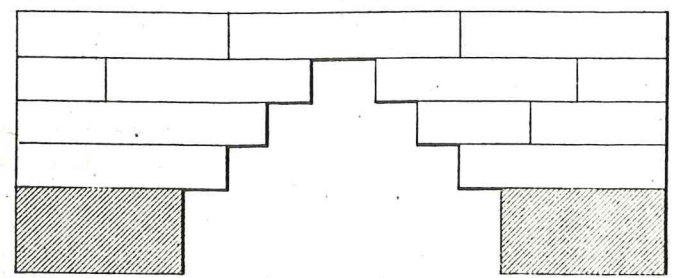
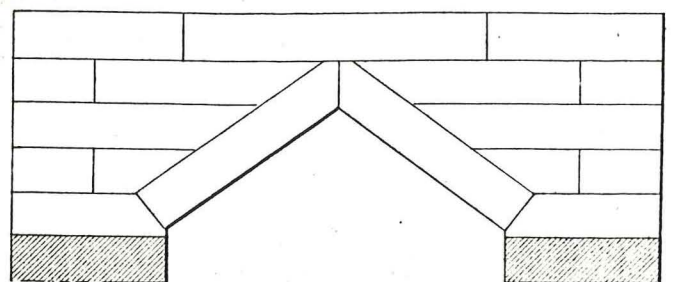
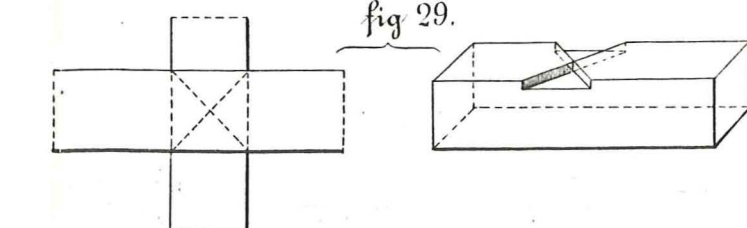
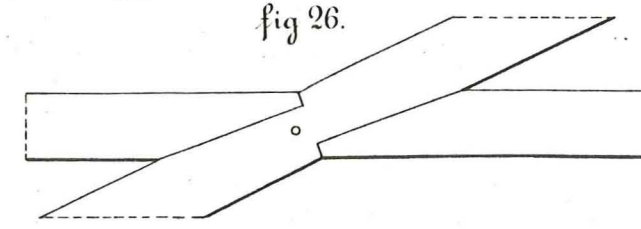
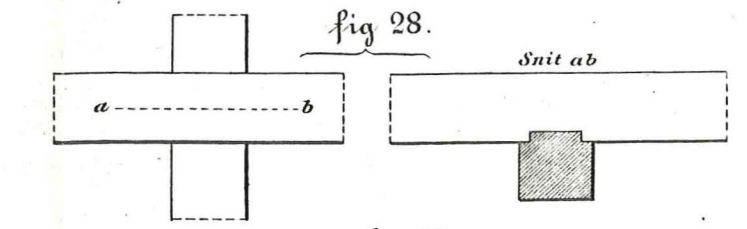
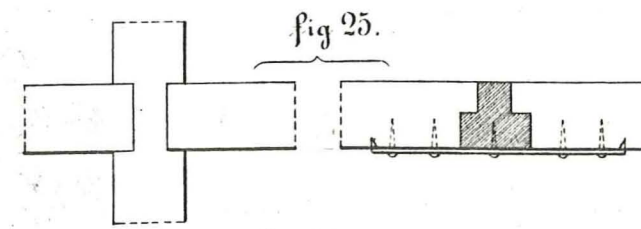
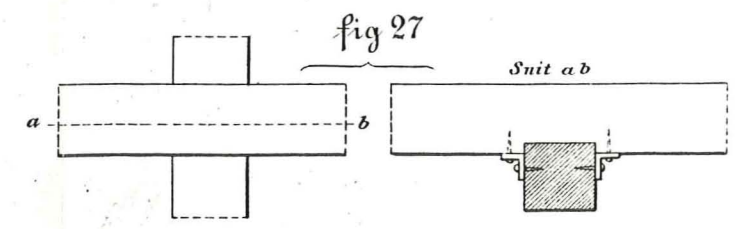
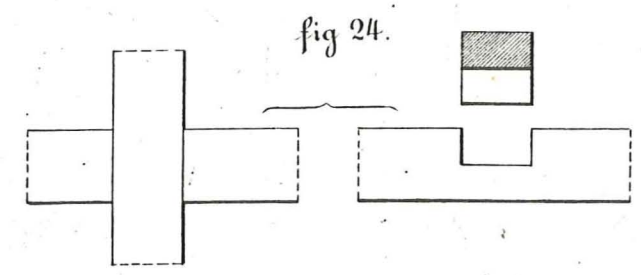
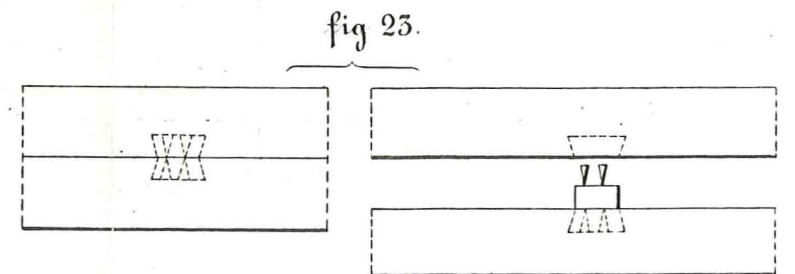
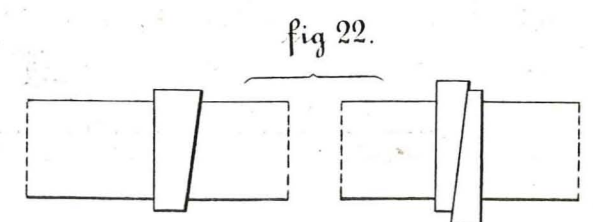
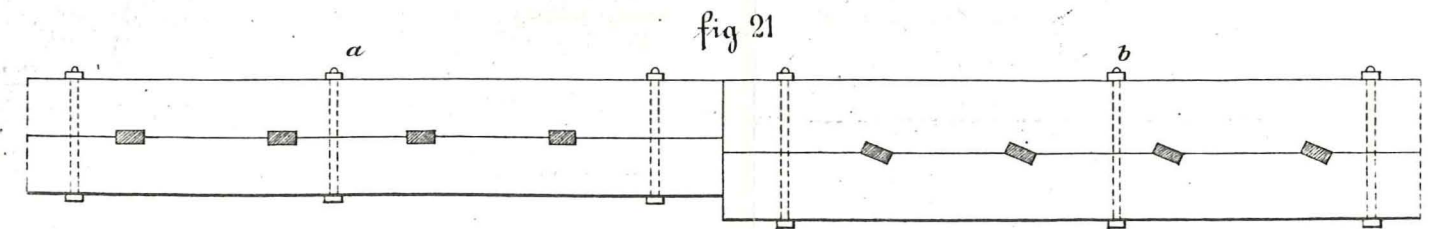
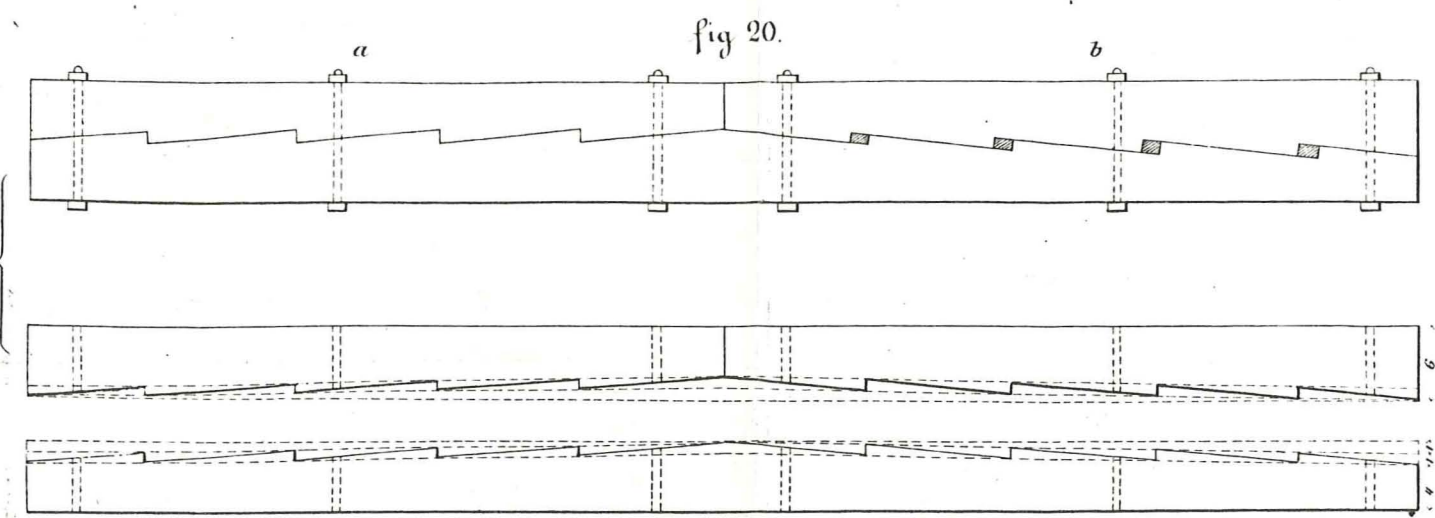
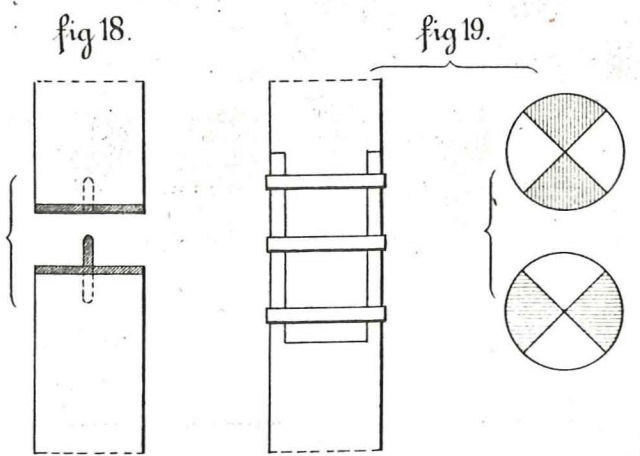
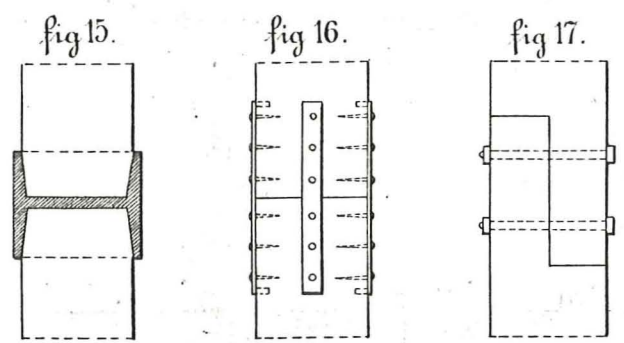
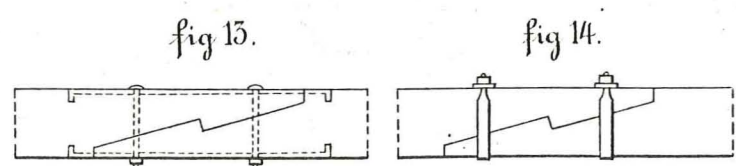
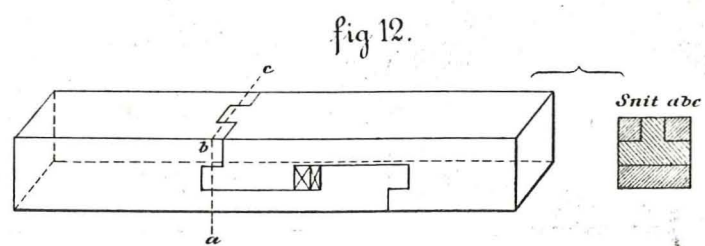
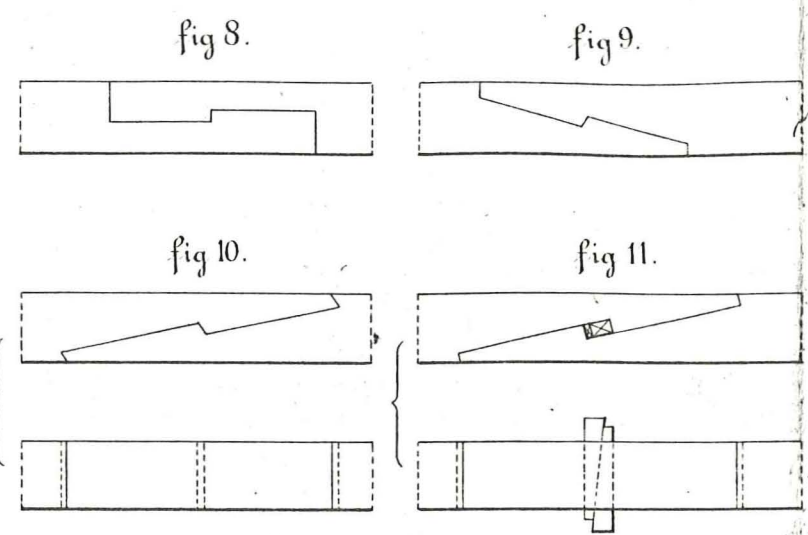
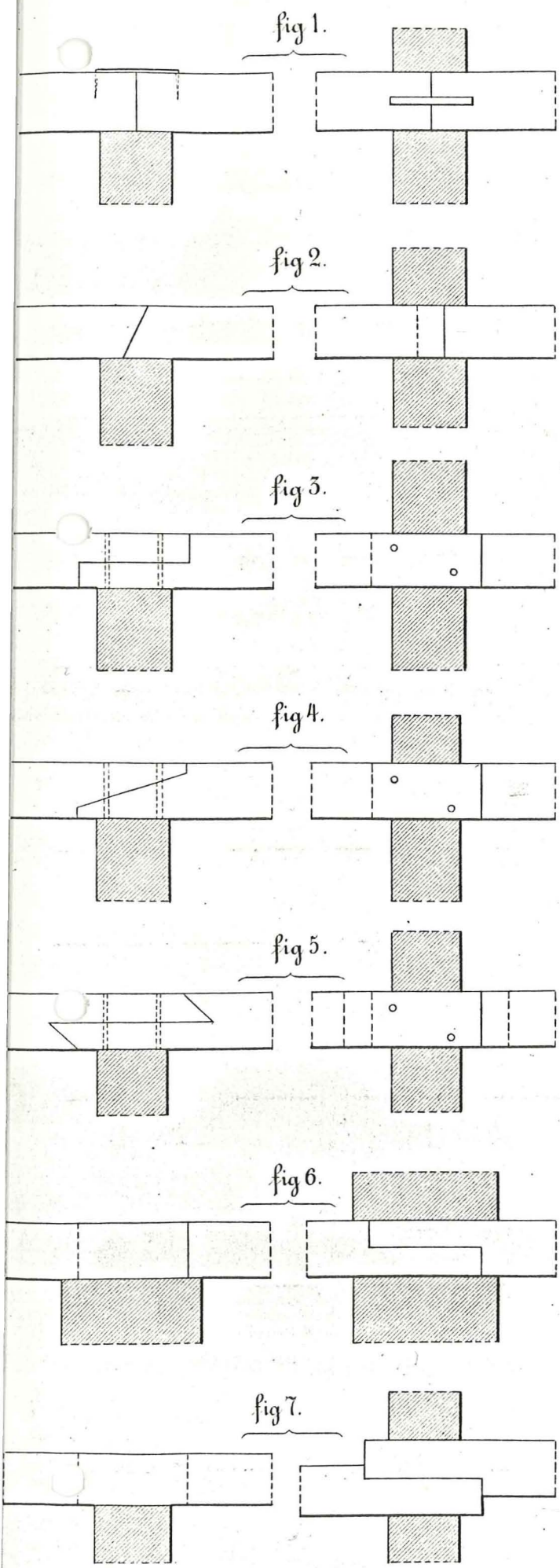

fig 12.









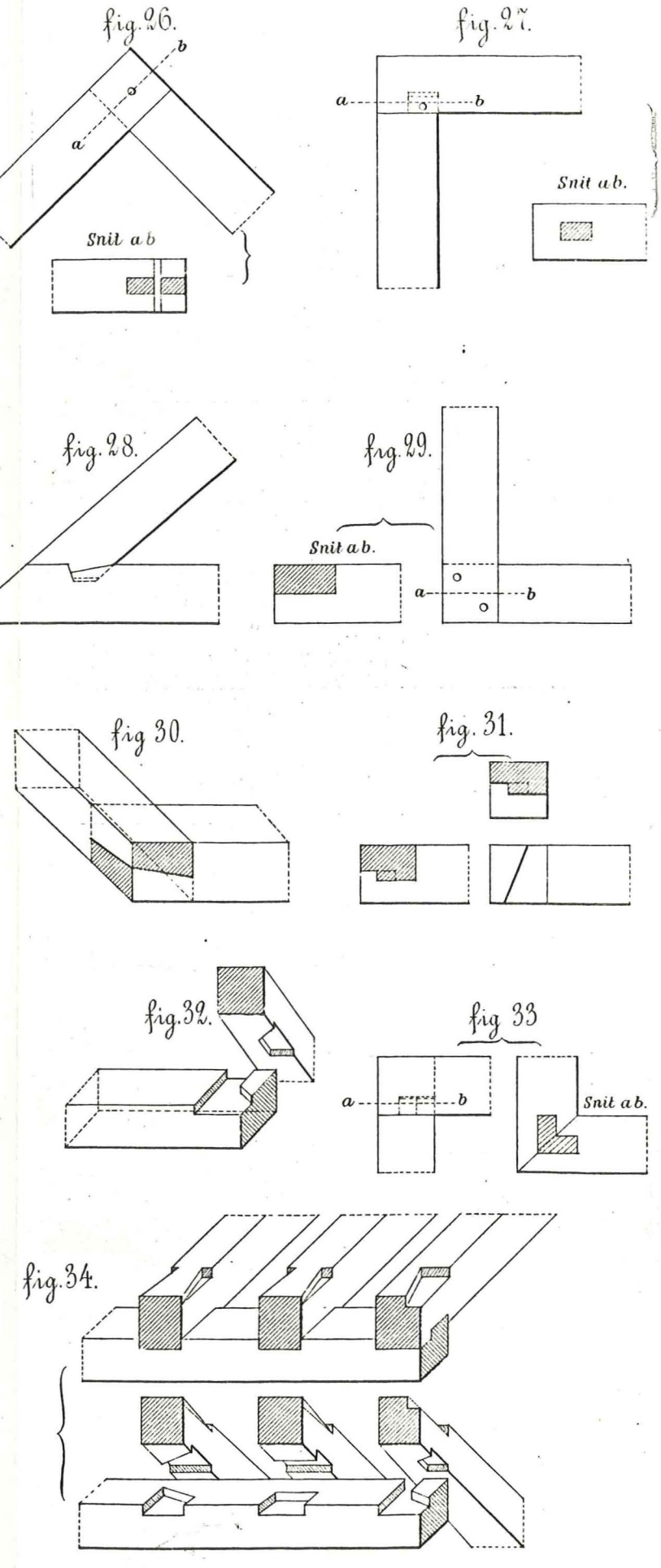
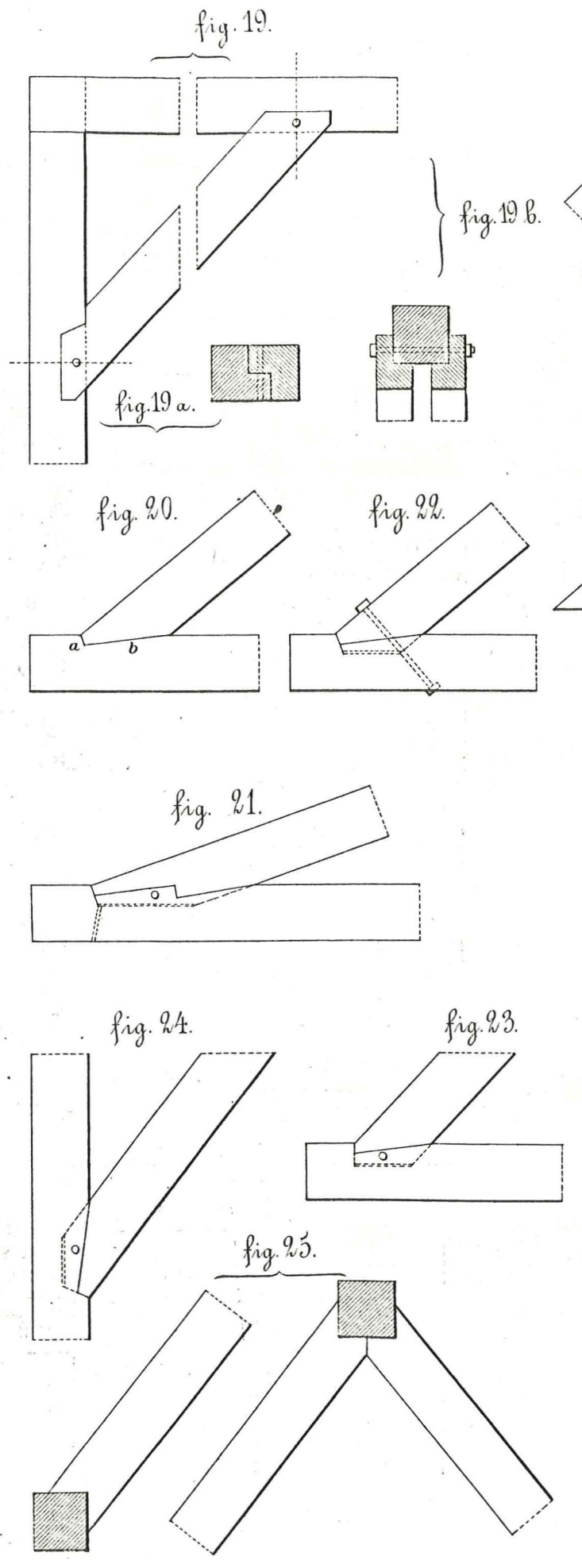
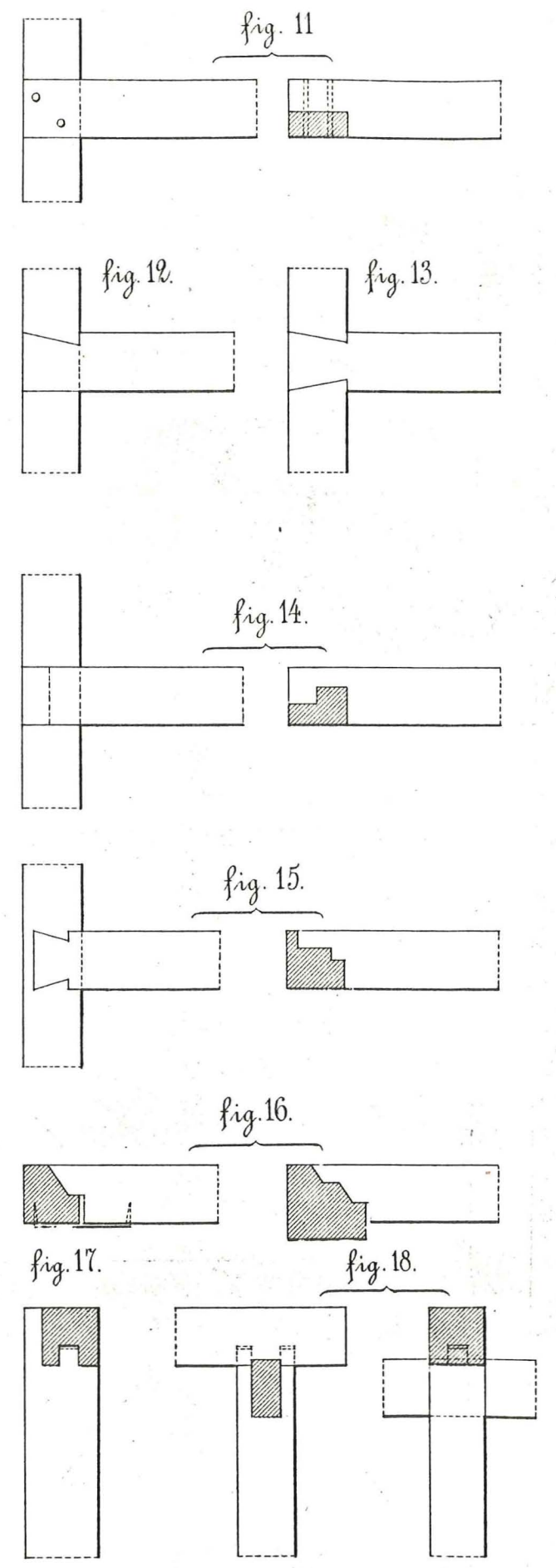
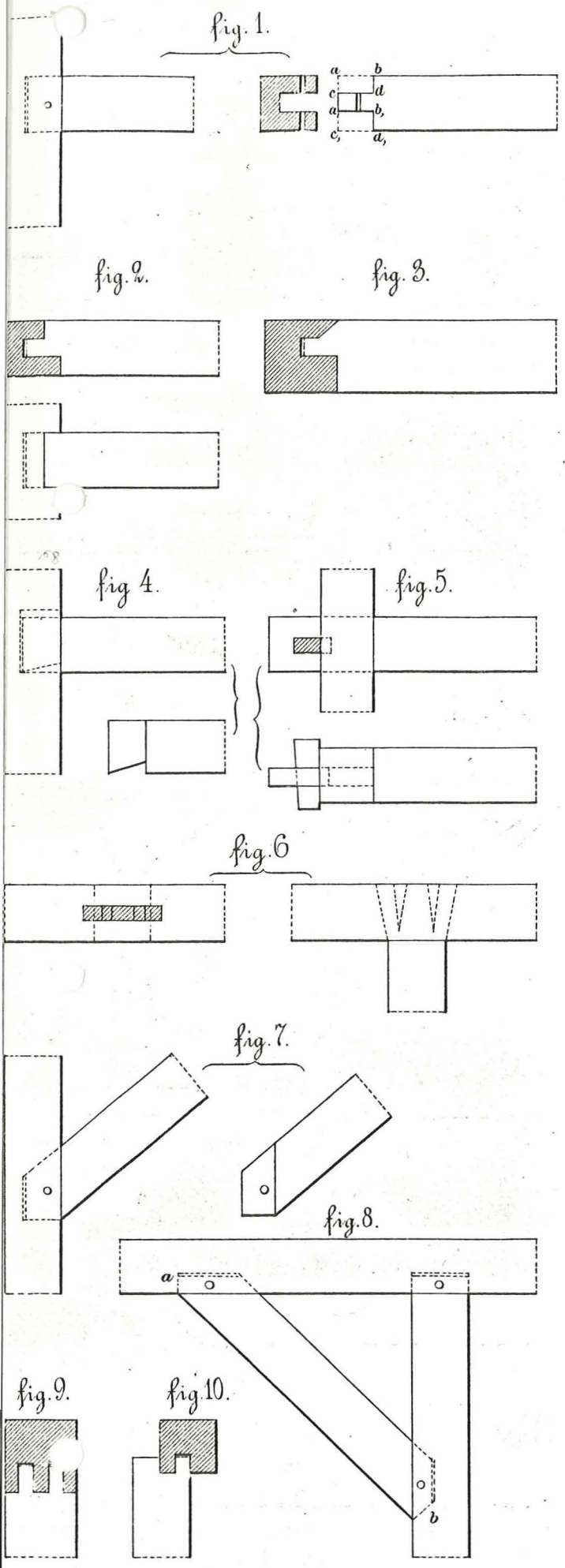



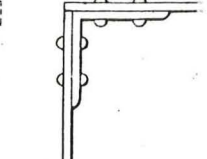
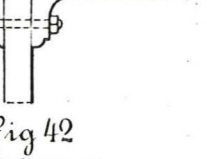
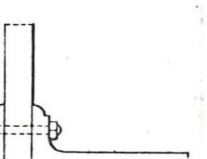
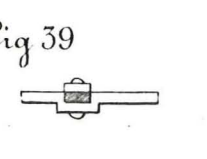
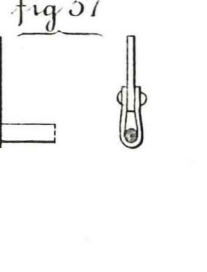
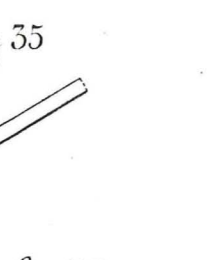
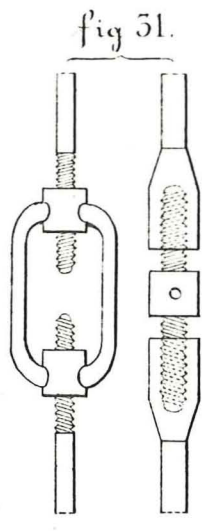
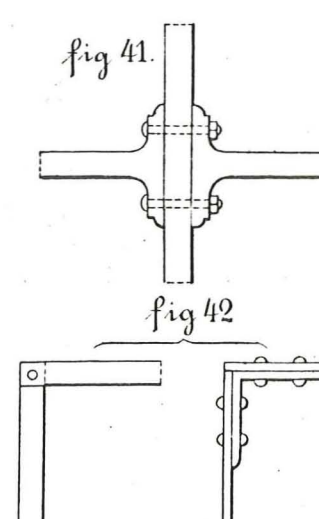
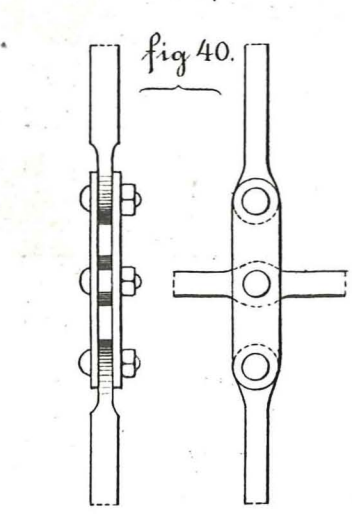
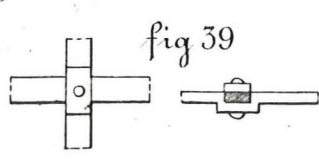
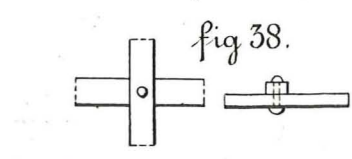
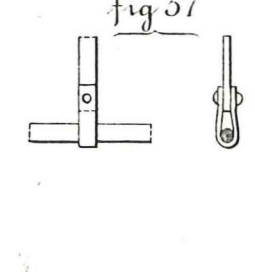
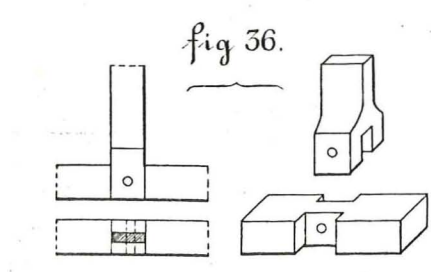
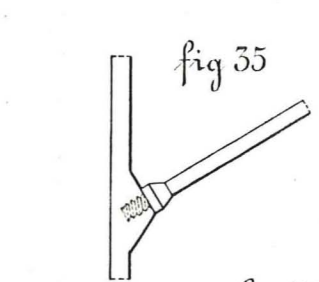
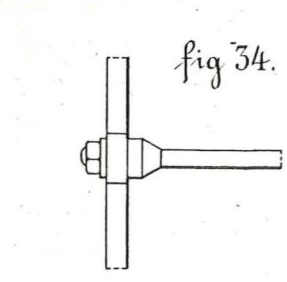
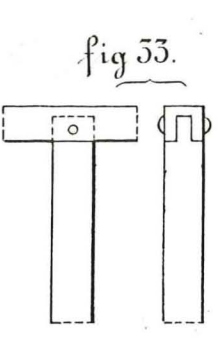
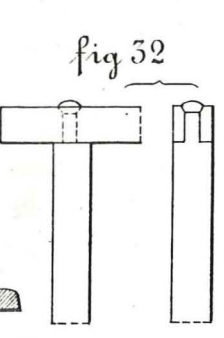
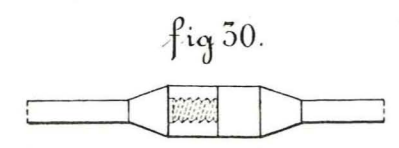
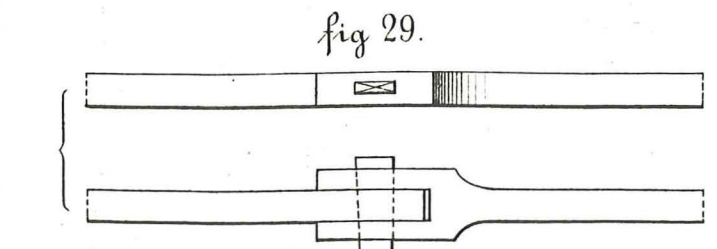
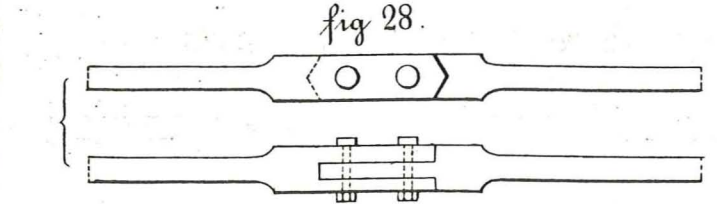
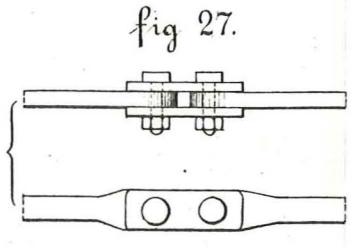
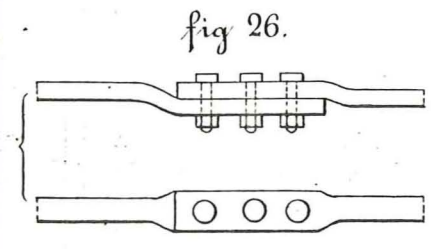
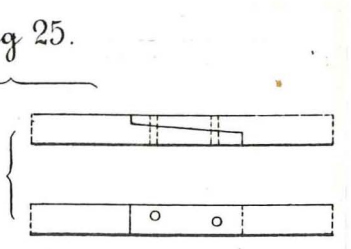
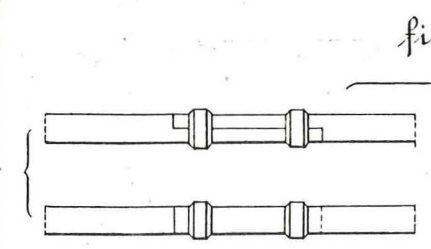
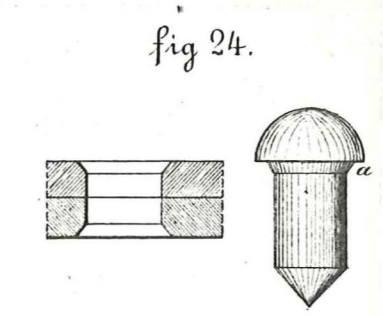
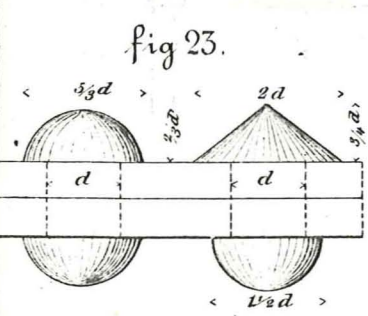
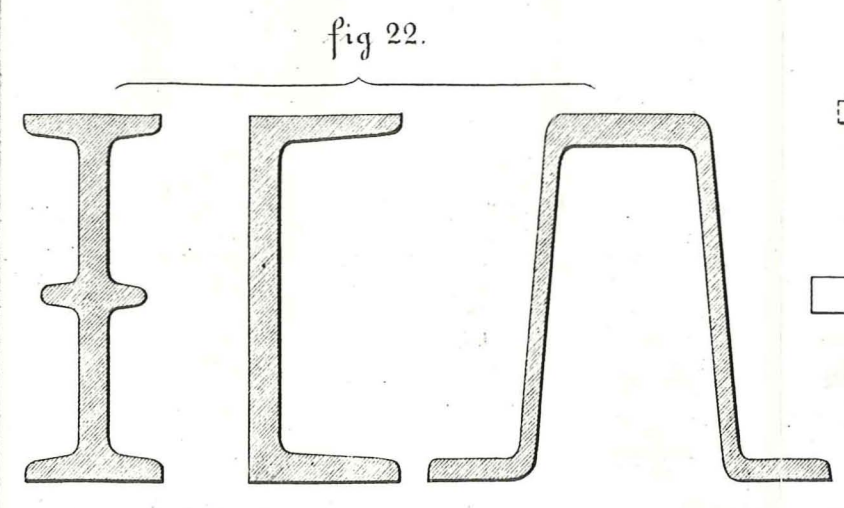
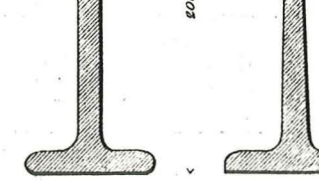
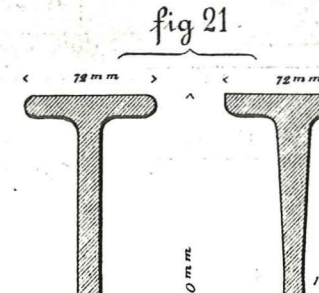
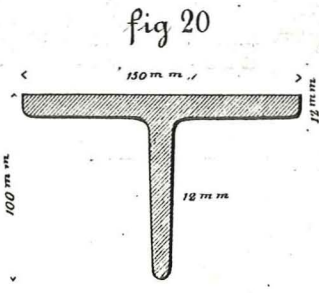
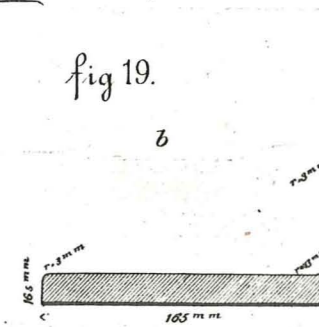
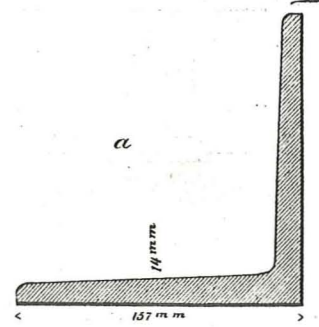
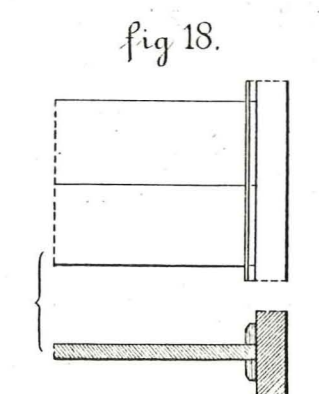
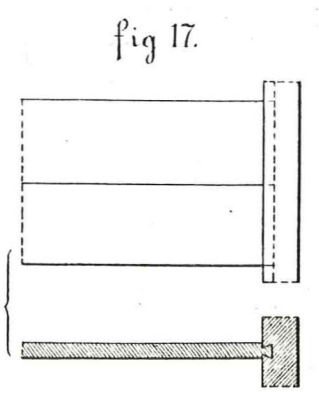
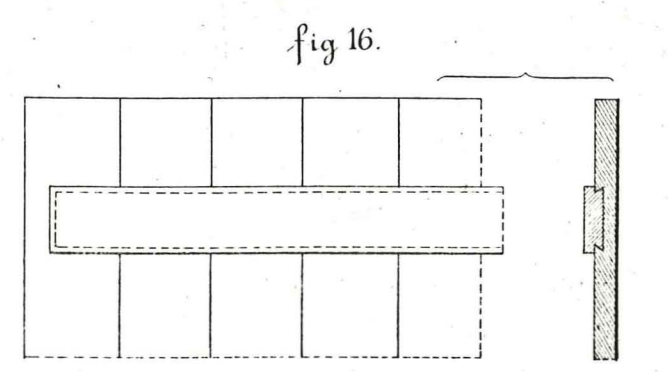
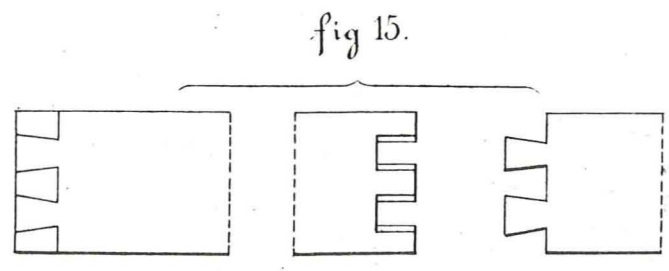
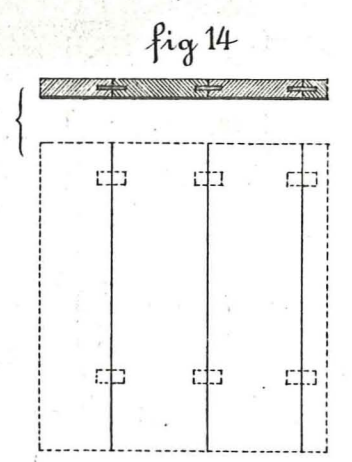
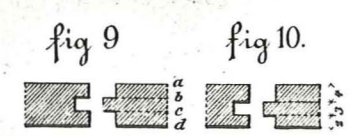
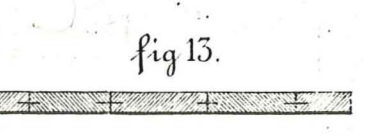
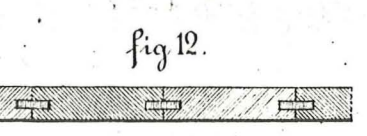
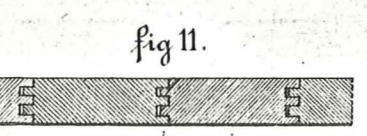
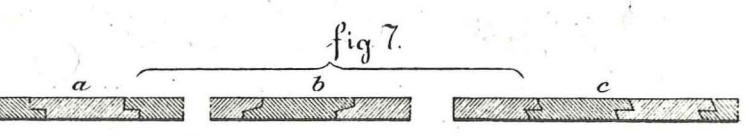
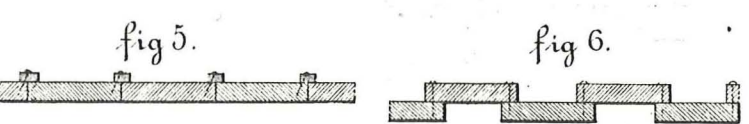
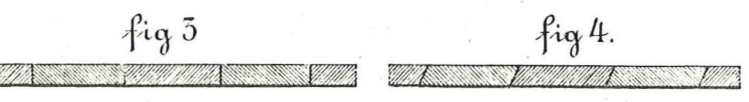
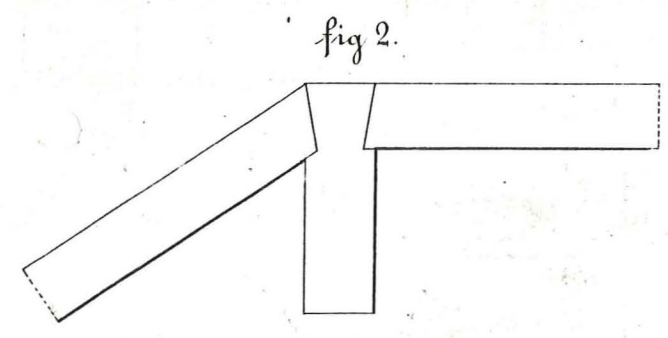
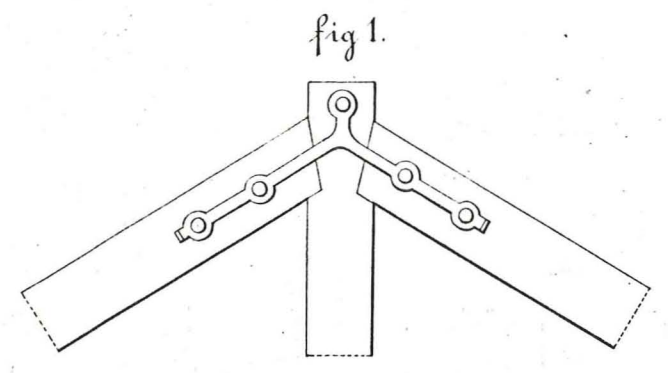



fig 1.

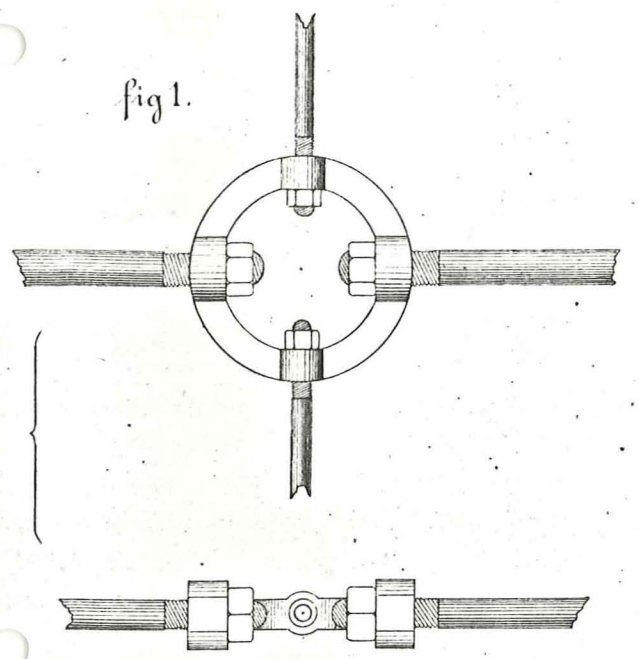

fig 2.

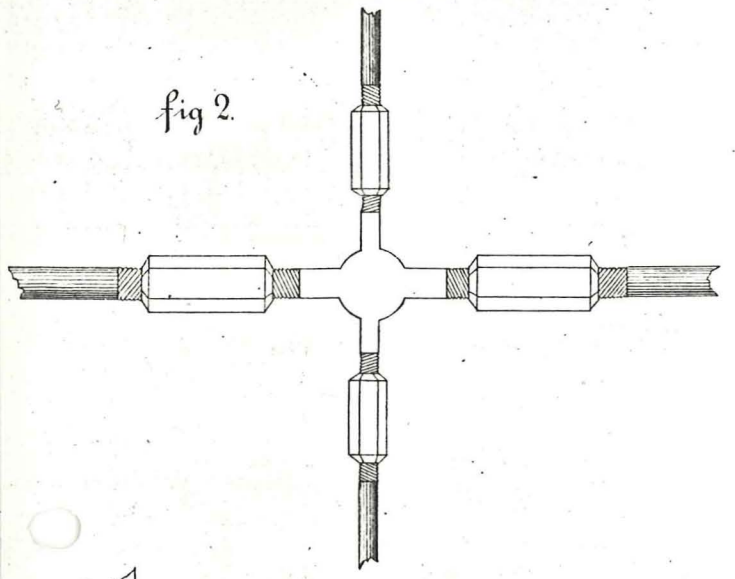

fig 3.

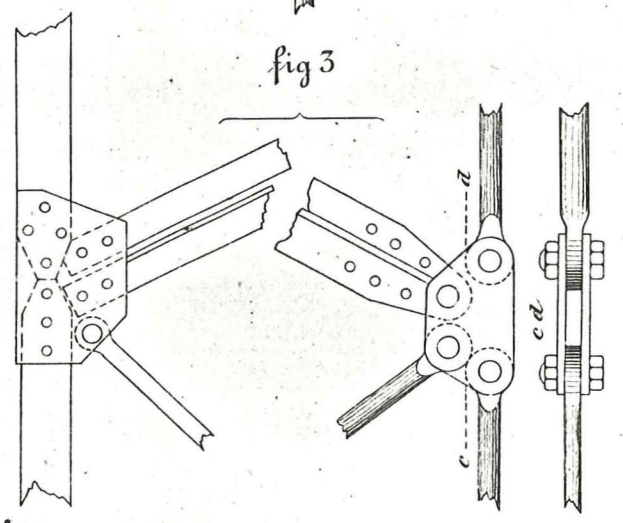

fig 4.

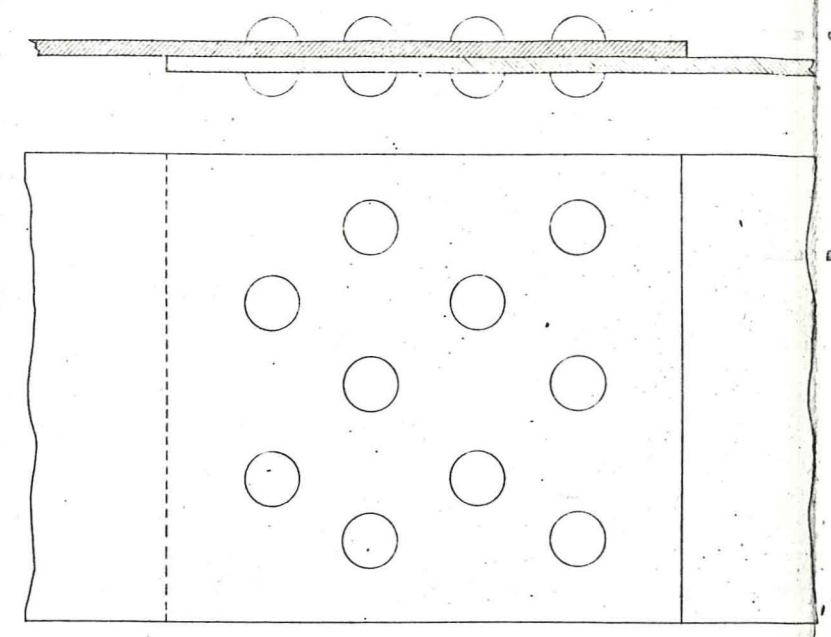

fig 5.

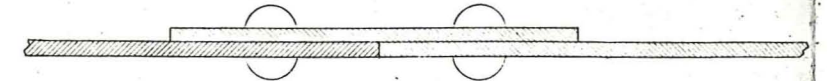

fig 6.

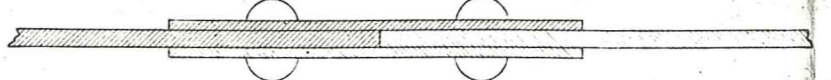

fig 7.



fig 8.

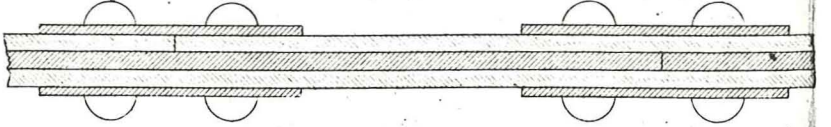

fig 9.

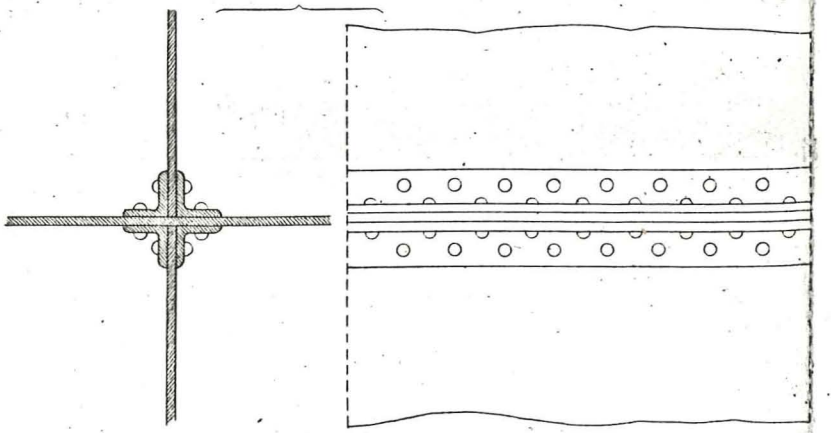

fig 10.



fig 11.

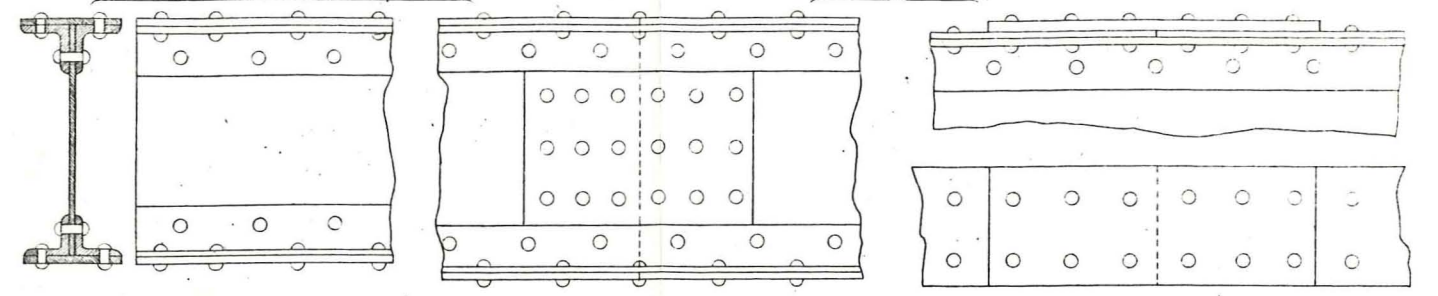

fig 12.

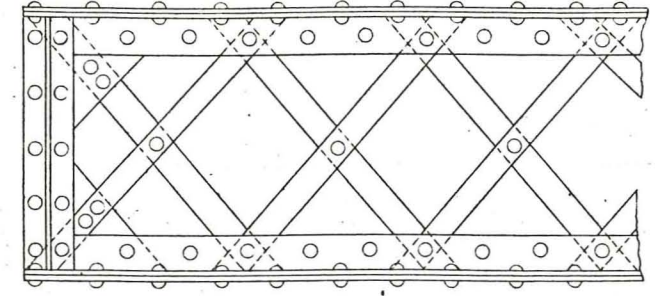

fig 15.

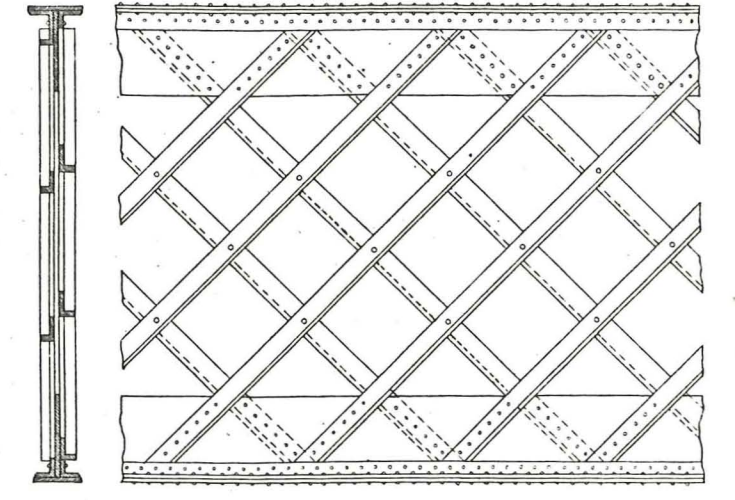
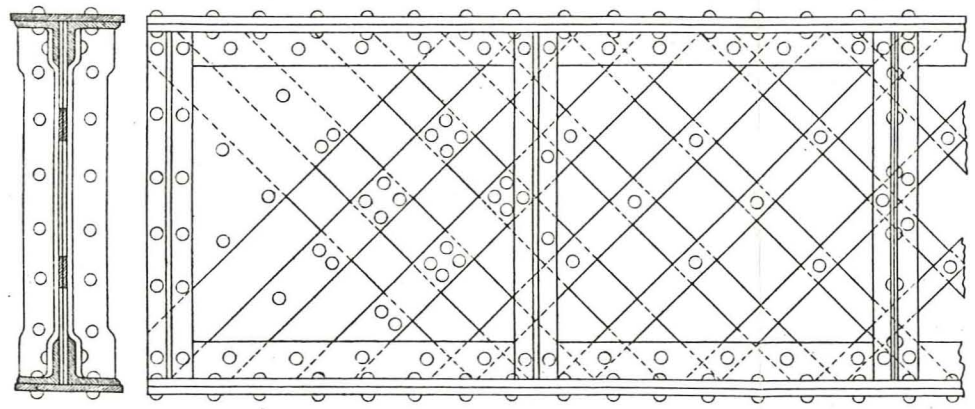
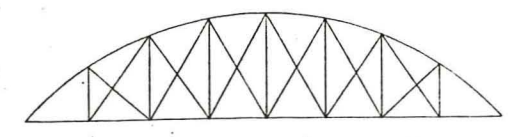

fig 14.



15a.



15b.

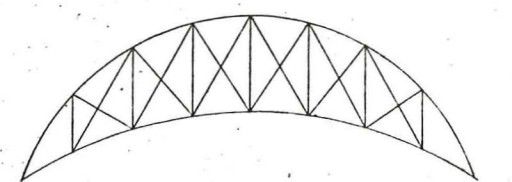

15c.

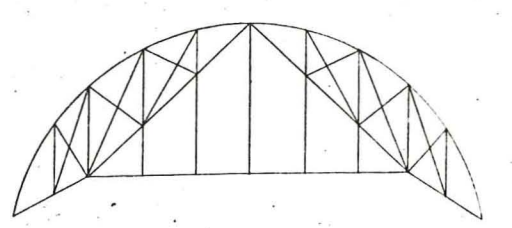

fig 16.

